

Tropic wooden pools OCTO | OCTO+

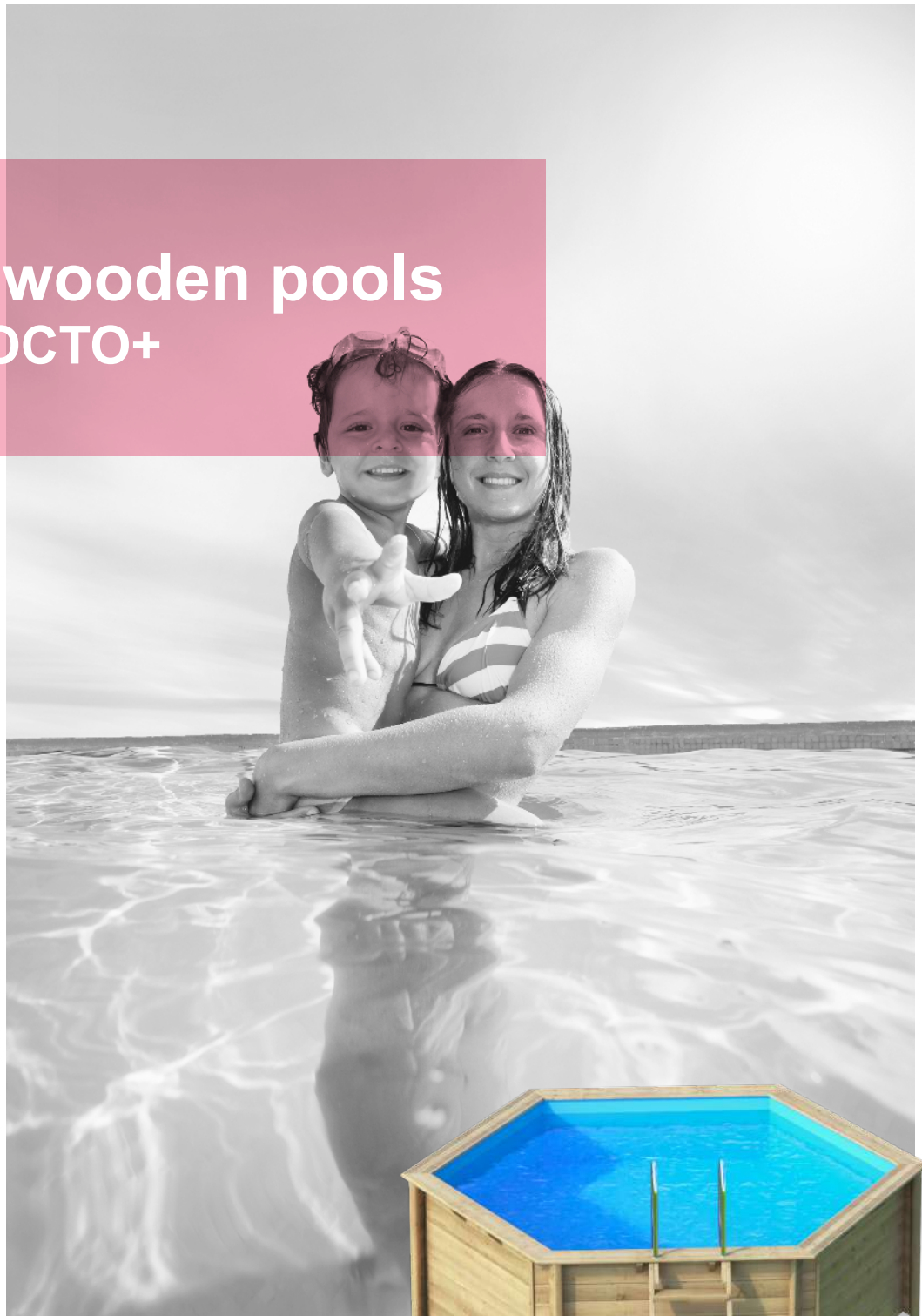

INSTALLATION AND OPERATING INSTRUCTIONS

to be read carefully and kept for future reference

1. WOOD, A NATURAL MATERIAL	4
1.1 Resin beads.....	4
1.2 Salt stains.....	4
1.3 Greying	4
1.4 Splitting and cracking	4
1.5 Knots.....	4
1.6 Joined wood.....	4
1.7 Surface mould	4
1.8 Colour variations	5
1.9 Curved wood	5
2. FOREWORD	5
3. STORAGE AND SAFETY	6
3.1 Storage.....	6
3.2 Safety	6
4. QUICK OVERVIEW	7
4.1 Tools.....	7
4.2 Time for assembly	7
5. SITING & PREPARATION OF THE GROUND FOR OCTO AND OCTO + POOLS.....	7
5.1 Octo pools	8
5.2 Octo + pools	8
6. ASSEMBLY OF THE OCTO POOL STRUCTURE	9
7. MOUNTING THE LINER LOCKING TRACK	11
8. FITTING THE FELT UNDERLAY.....	12
9. ASSEMBLY OF THE OCTO + POOL STRUCTURE	12
10. MOUNTING THE LINER LOCKING TRACK & FITTING THE UNDERLAY	17
11. POOL FITTING GASKETS	18
12. FITTING & CUTTING OUT THE LINER	19
13. ASSEMBLING AND COMMISSIONING THE FILTER GROUP	22
13.1 Filtration components components and specifications	22
13.2 Assembling the filter	24
13.3 Skimmer and return fitting connections.....	26
13.4 Pump filter & collector module.....	26
13.5 Pipe connections	27
14. FITTING THE COPING.....	27
15. ASSEMBLING AND INSTALLING THE STAINLESS STEEL LADDER.....	29
16. ASSEMBLING AND INSTALLING THE WOODEN LADDER.....	29

17. FILLING AND CHARGING THE CIRCUIT WITH WATER	31
17.1 Filling the pool	31
17.2 Filling the circuit with water	31
17.3 Commissioning & operating the filtration system.....	31
17.3.1 Commissioning and operating recommendations.....	31
17.3.2 Filter and valve operation.....	31
17.3.3 Length of the filtration cycle	32
17.3.4 Cleaning the pre-filter and backwashing.....	32
18. MAINTENANCE AND USE	33
18.1 Water treatment.....	34
18.2 Accessories.....	34
18.3 Winterizing the pool.....	35
18.4 Winterizing the hydraulic installation	35
18.5 Hygiene.....	35
19. SAFETY	36
19.1 Do not play with safety!!!	36
19.2 In the event of an accident	36
20. GUARANTEES.....	37
20.1 Wooden components	37
20.2 Accessories.....	37
20.3 Guarantee conditions covering components of accessories kit and optional equipment.....	37
21. EXPLODED VIEW - OCTO WOODEN STRUCTURE	40
22. EXPLODED VIEW - OCTO + WOODEN STRUCTURE	41

1. WOOD, A NATURAL MATERIAL

Being a natural material, wood will have some imperfections. These are normal and have no impact on the service life of the product. A certain number are superficial and do not fall within the scope of the guarantees.

1.1 Resin beads

When resinous wood species are autoclaved, the alternating pressure and vacuum can cause sticky residue to rise to the surface. To remove it, scrape it carefully with an appropriate tool, being careful not to touch the wood. Turpentine spirits could also be effective, but could stain the wood if too much is applied.



1.2 Salt stains

Les bois traités en autoclave montrent fréquemment de petites taches vertes en surface. Si vous le souhaitez, vous pouvez les poncer légèrement. Cette couleur disparaîtra dans le temps.

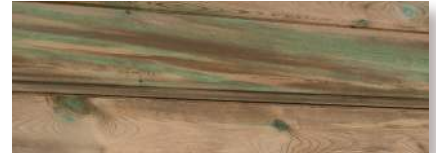

1.3 Greying

Wood exposed to the elements is susceptible to greying. Some people appreciate the silvery sheen of this natural patina.



1.4 Splitting and cracking

Wood expands and contracts when exposed to variations in humidity and temperature. As it dries, wood contracts unevenly resulting in the appearance of cracks. While these can seem to be cause for concern, they have no impact on the mechanical properties of the product and therefore do not fall within the scope of the guarantee.



1.5 Knots

Knots mark the places where branches were attached. The quantity and size depends on the species of wood and the sorting process. For outdoor installations, small adherent knots are acceptable. The more wood is sorted to limit the size and number of knots, the more expensive the wood.



1.6 Joined wood

To ensure the highest quality in the selection of our wood, it is sorted meticulously before planing. Sections that feature defects (knots, cracks, etc.) on both sides are removed and the wood is then joined together (see image). It is not unusual to find joined slats in the wooden pool structure as this in no way penalises the mechanical properties of the wood. Similarly, imperfections on the inner surface of the pool structure (knots, cracks, etc.) are also acceptable.



1.7 Surface mould

Mould, caused by microscopic fungi, can grow on wood, particularly on resinous species, on which the growth can appear as "blueing". It is a surface phenomenon, exacerbated by heat, humidity and inadequate aeration and is characterised by stains ranging from light to dark blue.

They can be removed by wiping the surface. Remember that class IV treated wood is protected against attack by fungi that could destroy the physical and mechanical properties of the wood. For more detail, see the MyPool guarantees covering the species and the treatment.



HOTLINE 0 892 686 970 Service 0,60 € / min
prix appel

1.8 Colour variations

Colour variations are common to every species of wood. Treatment brings them out because the depth of penetration of the product depends on the wood density and grain. Weathering of wood outdoors will significantly attenuate these colour variations.



⚠ During storage. If you do not intend to assemble your pool immediately, you should store it without opening it, in a well ventilated room, or failing this, in an area protected from the elements and sunlight. If you had to unpack, you must repack and restrap the pallets. Once the pallets are undone, the wooden structure must be assembled within 24 to 48 hours.

1.9 Curved wood

Due to the constant pressure exerted by the water, the walls of the pool may curve slightly over time.

This phenomenon, attributable to the natural elasticity of wood, will stabilise of its own accord and in no way would lead to failure of the wooden slats.

It is not a defect, and would not constitute grounds for a guarantee claim.

2. FOREWORD

Congratulations on acquiring your pool. We have taken great care with the design and manufacture of your pool to provide you with a top quality product.

The wood used to make the various elements (interlocking walls, coping, ladder, etc.) was carefully selected. Outdoors, these wooden elements are subject to constant weathering: contact with the ground, temperature variations, exposure to sunlight, rain and frost, insect attack, etc. The wood's ability to withstand this aggression depends on the origin of the wood and the method used to treat it.

For this reason, we choose pine from extensive, sustainably managed forests in northern Europe. Why do we insist on this? Because the more rigorous climates above the 57th parallel favour very slow tree growth, making the wood stronger and more resilient.

The wood is autoclaved, this involves subjecting the wood alternately to pressure and vacuum in order to drive the treatment chemicals into the heart of the wood as opposed to other more superficial treatment techniques such as soaking.

Class IV treated wood in contact with the ground is immune to insect attack and rotting caused by humidity.

Autoclave treatment is guaranteed 10 years, in accordance with standards currently in effect.

The pool coping is made of treated PINE planks.

Wood is a living material, variations in temperature and humidity can cause it to expand or contract so take care to follow the storage and assembly instructions concerning the wooden structure. Similarly, prolonged exposure to UV light can cause wood to grey. These are natural phenomena that in no way effect the service life of the products.

Do not apply any product to the wood (for example: lazure, micro-porous products, etc.).

3. STORAGE AND SAFETY

We shall now explain how to assemble your pool, but first some instructions before you begin.

Please read these instructions carefully, this will allow you to prepare each stage to achieve optimum efficiency. Please keep these instructions for future reference.

You should take the time to go through the components using the nomenclature page enclosed with the accessories kit and make sure that no items are missing.

Please retain the following documents;

- the production sheets for the various kits
- proofs of purchase.

3.1 Storage

If you do not intend to assemble your pool immediately, you should store it without opening it, in a well ventilated room, or failing this, in an area protected from the elements and sunlight. Once the pallets are undone, the kit must be assembled within 24 hours. Once work has begun, try to avoid leaving the structure exposed to significant climatic variations that could cause the wood to “work” too quickly. This could lead to deformations that could render the item unusable. By preference, the wooden structure should be assembled in one go on a day that is not too hot. The liner or PVC waterproofing membrane should be stored at a minimum of 20°C for at least 24 hours before it is fitted. This is to render the liner more supple and thus facilitate fitting. The liner should only be fitted if the ambient temperature is higher than 20 °C.

3.2 Safety

- Your installation should comply with the standard C15-100. Notably, the electrical supply of the pump should be protected by a 30mA differential circuit breaker. (Wiring should be carried out by a qualified professional).
- The kit provided will allow installation of the filtration system 3.5 m from the pool, this is in line with pool safety standards.

We recommend that you secure access to the pool using one of the protective measures set out in the pool safety standards NF P 90-306, 307, 308 & 309 that is: Barriers - Alarms - Safety covers - Shelters.

- Children should only use the pool under the supervision of an adult.
- Remember to remove the exterior wooden ladder while the pool is not in use to prevent unsupervised access to the pool.
- This pool is intended for private use only.
- Do not install the pool beneath electrical wires.

4. QUICK OVERVIEW

- Excavation
- Assembly of the metal structure
- Pouring the concrete slab
- The wooden structure
- The filtration group

4.1 Tools

decameter	tube wrench (13 and 17)	a large spirit level
rope	a screw gun (with a torx pozi bit)	a bolt cutter
mallet	a flat head and a cross head screwdriver	sand paper
metal saw	a file & earthwork equipment.	a Stanley knife

(hors mise en oeuvre béton et fouilles)

4.2 Time for assembly

- Excavation: 1 to 2 days (depending on the materials used).
- Metallic structure: 1 day (with 2 people).
- Pouring the slab: 1 to 2 days (with 2 people, depending on the materials used).
- Wooden structure and filtration: 2 to 3 days (with 2 people). The time indicated does not include the concrete curing time.
- Curing of the concrete slab before filling the pool with water: 2 to 3 weeks.

CAUTION

Once the structure has been assembled, the liner must be fitted and the pool must be filled with water within at most 5 days. Past this time limit, the structure will need to be carefully inspected to ensure the absence of any deformation (movement of the slats, shrinkage, etc.) that could impact the structural integrity of the work. In the event that gaps appear between the slats, reengage the slats properly before fitting the liner.

5. SITING & PREPARATION OF THE GROUND FOR OCTO AND OCTO + POOLS

This is the most important step in the procedure as the pool site will determine the service life of your pool. There are some rules that must be respected.

Given the vast variation possible (slope, type and homogeneity of the ground, possible issues with drainage, etc) we cannot provide recommendations for every possible permutation here. Some optional steps, such as pouring a concrete slab, laying foundations, footing, laying drains, etc will require assistance from professionals who will be able to advise you on solutions best suited to your configuration.

We will explain how to prepare the ground without any concrete, the objective being to achieve a flat, level bearing surface. In as far as possible, avoid siting your pool under trees (to stop you pool from being filled with leaves) or near rises or dips in the ground that could expose children to danger. Do not assemble your pool under electrical cables. The pool should be at least 3.50m from any electrical source (French safety standard C15-100). On a slope, never back fill under your pool to bring the bearing surface level, always cut into the upward slope.

Lastly, avoid preparing the ground and assembling the pool while a strong wind is blowing.

How should the pool be oriented?

Ideally, the pool should be oriented so that the skimmers are facing into the prevailing wind. This will determine the final orientation of your pool and the manner in which it will lie in your garden, notably in the case of elongated pools.

5.1 Octo pools

For above-ground configurations only. Stable surface:

That is to say, properly consolidated soil that has not been subject to recent backfill.

Even after 15 years, backfilled soil may not be completely stabilised.

To begin, clear the ground of plants and other miscellaneous objects. Next, level and smooth the surface using a spade, rake and a pickaxe (if necessary). Make sure that you smooth out any bumps or rough areas that could damage the underlay, or more seriously, the liner.

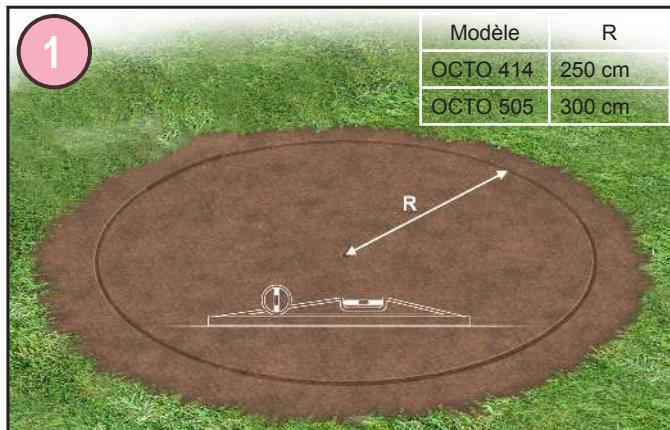

After a rough preparation of the surface, plant a stake in the centre of the circle and mark the point where it comes into contact with the ground. Next, using a flat, straight piece of wood longer than the radius of your pool, go around the circle checking that the ground is level. This operation requires two people (one to make sure that the bottom of the wood corresponds to the mark on the stake, and the other to check the level and move the wood around the entire circumference to ensure that the surface is perfectly level).

5.2 Octo + pools

Trace out site of the pool and clear the ground of plants, grass and other miscellaneous objects.

Next, level and smooth the surface using a spade, rake and a pickaxe (if necessary). Make sure that you smooth out any bumps or rough areas that could damage the underlay, or more seriously, the waterproofing membrane.

Make sure that the bearing surface is completely flat and perfectly level.

Once the ground has been prepared, use string to mark out the longitudinal axis (A1) of your pool and then the transversal axis (A2) perpendicular to the axis A1.

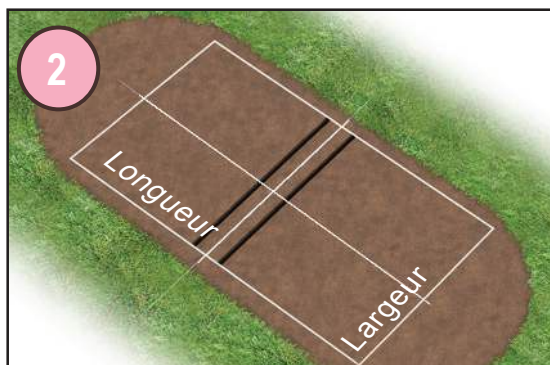

OVERVIEW		
	LENGTH	WIDTH
+450	460	330
+510	510	360
+540	540	330
+640	640	400

6. ASSEMBLY OF THE OCTO POOL STRUCTURE

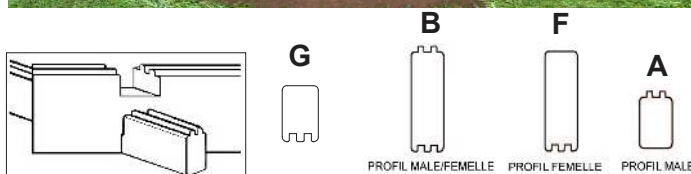
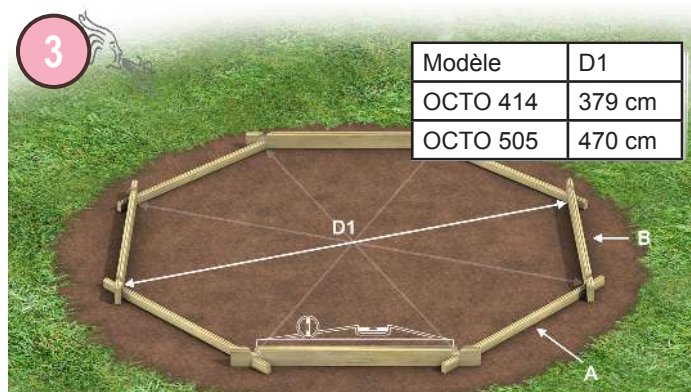

Before you begin, familiarise yourself with the nomenclature enclosed in the “Waterproofing” kit and the exploded view (at the end of this notice) that corresponds to your pool.

Determine the final orientation of your pool, by preference, the skimmers should be oriented so that they are facing into the prevailing winds. Skimmers must be mounted on a side that starts with a type A slat.

While assembling the walls, make sure that each slat is fully engaged before starting on the next.

You may need to use a hammer and a clamp to remedy any slight warping of the slats. Do not strike the wood directly, use the protective brace (provided).

During assembly, check regularly that the walls are level and the 4 diagonals are equal in length.

To avoid the risk of injury or damage to the liner, take care to eliminate any splinters during and after assembly.

If you intend to fit your pool with a counter swim treadmill, you will need to incorporate the 2 slats specially prepared to mount this option.

Fit the 4 half slats (type A - smooth side facing down) together with 4 male/ female slats (type B), grooves facing down, double tongues facing up (see the detail below.).



Fit together the remaining slats (type B) taking care to position the slat that will hold the return fitting (type C) and the machined slat (type D) correctly. The slat that will hold the return fitting should be positioned over 4 (type B) slats + 1 type A slat in the case of a skimmer and an autonomous filtration unit. The return fitting slat should be located just under the machined (type D) slat which should be in the last row of slats at this point in the assembly.



At this point, fit the skimmer or autonomous filtration unit into the bottom skimmer slat (type D).



Fit the two slats at either side of the filtration unit or fit the top skimmer slat (type E) over the bottom skimmer slat (type D), and continue around the pool with 3 type F slats and 4 type G half-slats as illustrated.

Paint the ends of the slats in the corners with a wood stabiliser to limit deformation over time.

This product is white on application, but becomes colourless when dry. Drying time is 2 to 3 hours. Apply a second layer if the temperature is high or if the product dries too quickly.

Follow the safety instructions printed on the container. Rinse the brush after use.

IMPORTANT

The structural dimensions and measurements listed have a tolerance of +/- 3% (European standard EN 16582-1). The AFNOR AC P90-321 agreement allows the following deviation in terms of depth:

- For a depth less than or equal to 25m : +/-3cm
- For a depth greater than 1.25m and less than or equal to 1.65m : +/-5cm
- For a depth greater than 1.65m : +/-8cm

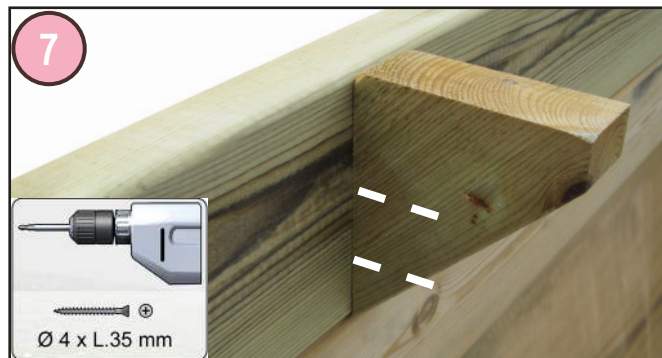

The corbels will support the coping that will be mounted after the pool is filled. Pre-drill the wall from inside the pool then attach each wooden bracket (type L) using 2 screws (5x100mm sachet J) taking care to position them flush with the top of the structure. Remove any splinters that may have been raised during this process.

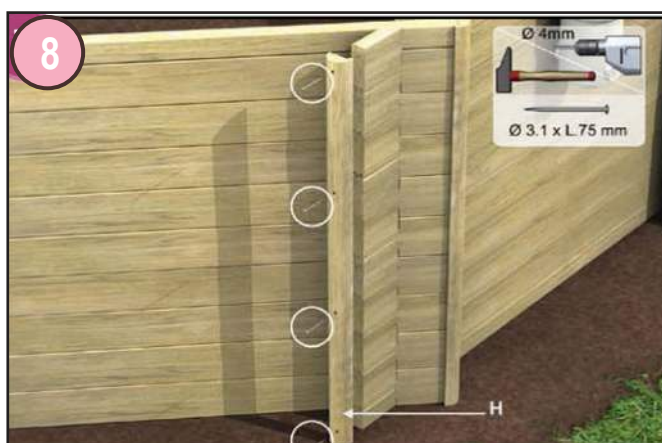

Mount a decorative profile (type H) on the end of each wall using nails (3.1x75mm) inserted through evenly spaced holes pre-drilled along the axis of the profile.

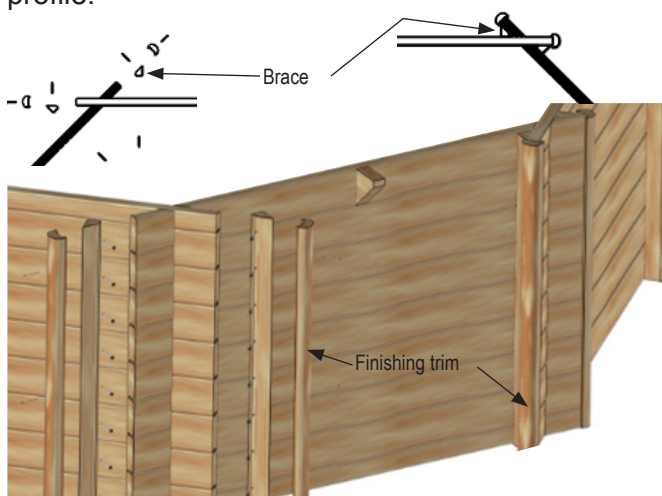

To attach the brace from the outside: locate the screws 100mm from the corner. Use one screw per slat.

To attach the brace from the inside: Locate the screws 85mm from the corner. Use one screw per slat.

Paint the ends of the slats in all the corners with a wood stabiliser to prevent deformation over time.

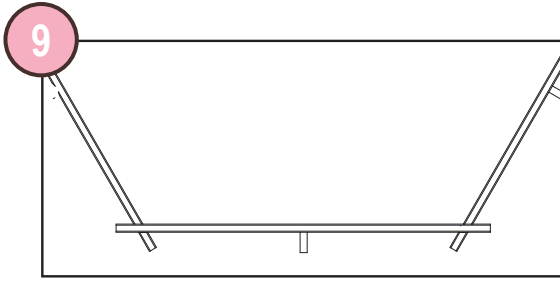

There is one corbel per side (except the side that houses the skimmer). Centre the corbel.

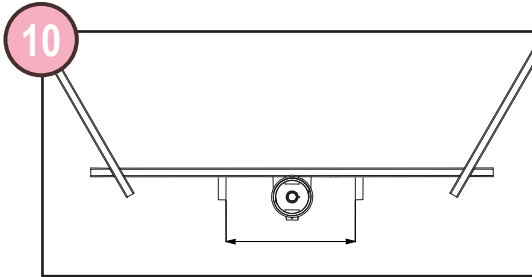

Mount 2 wooden brackets on the wall holding the skimmer, they should be positioned 75 cm apart and equidistant from the skimmer axis.

CAUTION

Once the structure has been assembled, the liner must be fitted and the pool must be filled with water within at most 5 days. Past this time limit, the structure will need to be carefully inspected to ensure the absence of any deformation (movement of the slats, shrinkage, etc.) that could impact the structural integrity of the work. In the event that gaps appear between the slats, reengage the slats properly before fitting the liner.

7. MOUNTING THE LINER LOCKING TRACK

Check that the structure is correctly assembled before mounting the liner locking track.

To do this:

- use a spirit level to check that the structure is horizontal around the entire periphery.
- - check that the 4 diagonals are equal in length.

Fix any imperfections before continuing.

The liner locking track should be flush with the top of the wooden structure.

Before mounting the liner locking track, pre-drill using a \varnothing 3mm drill bit. Avoid over tightening, this could cause the screws to break through the track.

Each side of the pool is fitted with one track 1.18 m long and another track trimmed to fit, see the table below.

Trim 8 tracks according to the table below. Before making the cuts, check that the total length of the track is equal to the length of the wall less 10 cm. Use a mitre box to ensure that the cuts are clean and straight. Deburr the cuts using the fine grain file.

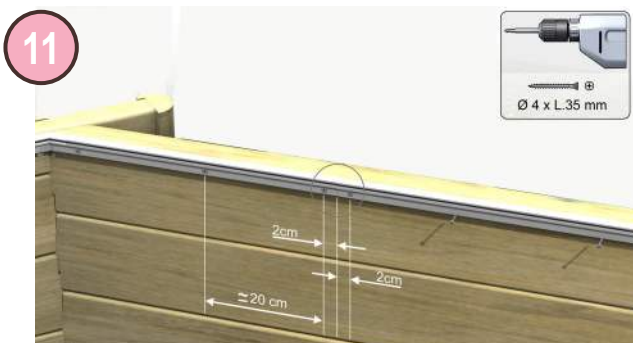

To hold the track in position, drive in a screw 2 cm from each end. Next finish attaching the track by driving in screws at 20 cm intervals. Use \varnothing 4 x 35 screws (bag D).

POOL MODEL	SHORT SIDE
Octo 414	1.18+0.26
Octo 505	1.18+0.61

8. FITTING THE FELT UNDERLAY

Important ! The ground underneath the underlay should be absolutely flat and free of any bumps or rough areas to avoid any damage to the liner. Because of the pressure exerted by the water, even the smallest bump will be visible underneath the liner. After clearing the ground, spread a layer of sand mixed with cement (1 part cement to 7 parts sand) over the floor of the pool and compact it. This layer should be no more than 1 cm deep. (The sand and cement are not supplied). Unfold the underlay in the pool taking care to line it up correctly with the corners. Smooth out any wrinkles. The underlay will be slightly smaller than the pool structure.



9. ASSEMBLY OF THE OCTO + POOL STRUCTURE

The pool structure is mounted in two stages:

- Stage 1, excavation of the site and installation of the cradles designed to reinforce the lateral walls. A cradle comprises a cross beam, vertical posts and metallic plates to be bolted together.
- Stage 2, assembly of the wooden structure and fitting of the additional items (liner, coping, etc.).

We recommend that the pool structure be assembled by two people.

Before you begin, familiarise yourself with the nomenclature page (enclosed with the Accessories kit) and the main exploded view (at the end of this document) that corresponds to your pool.

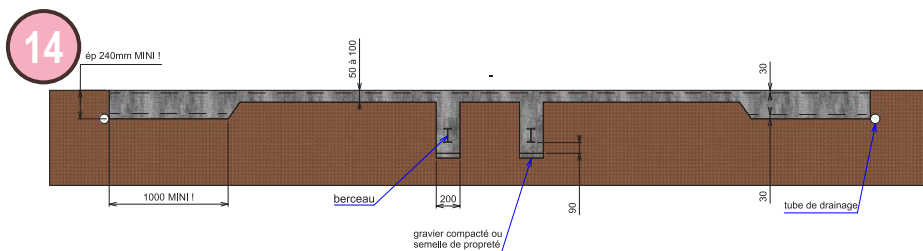

Slab schematic

In the case of a concrete slab, the cradles should be sealed into the slab and a peripheral drain should be created.

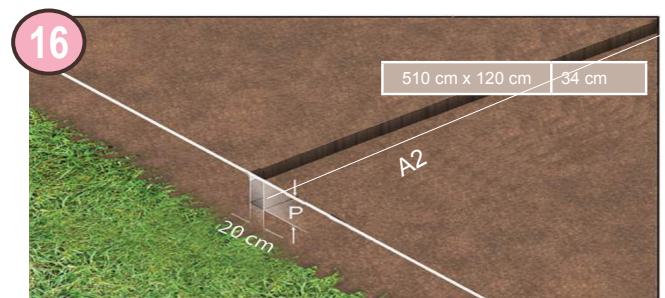

HOTLINE 0 892 686 970 Service 0,60 € / min * prix appel

You will need to dig shallow trenches to hold the cradles. Make sure that these are parallel to each other and to the A2 axle. The number of trenches required will depend on the pool model, refer to the illustrations corresponding to your pool. Trenches should be regular and sized to hold the cradles in the right position.

Please note that 510 and 450 models feature only 1 cradle.

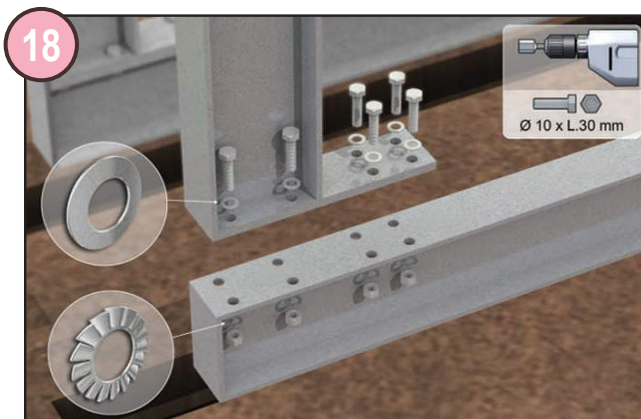
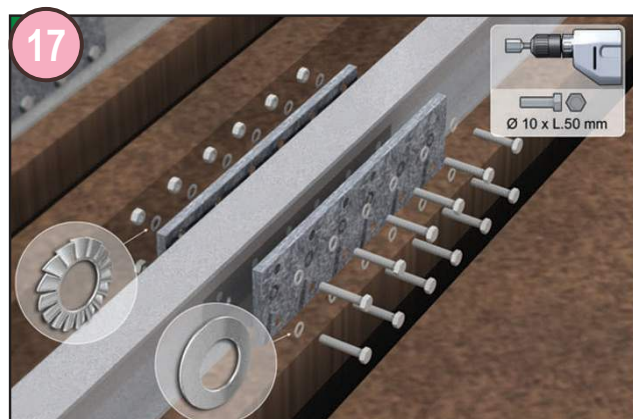

Lay the cradle components out beside the trench and fit them together (using the cradle kit).

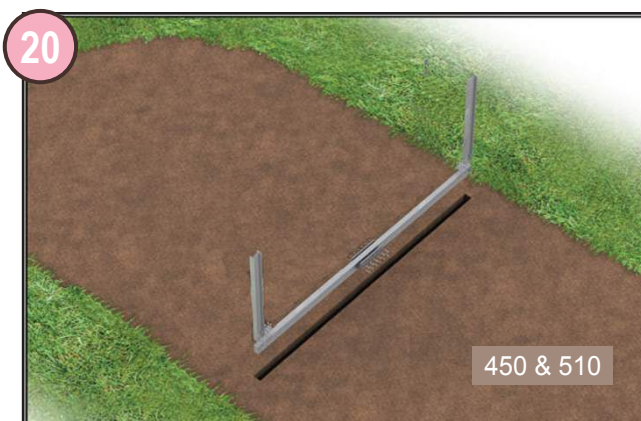
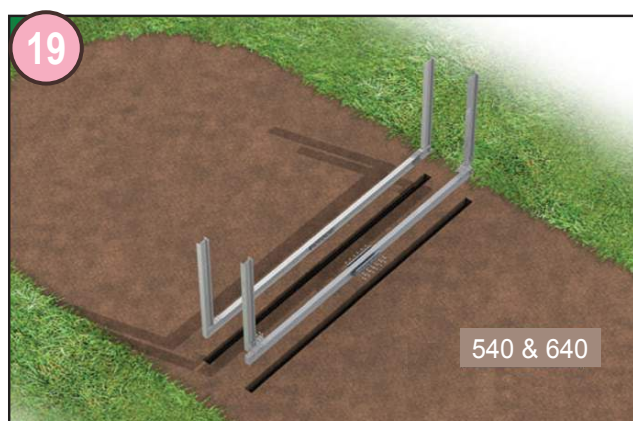

Once the cradles have been assembled, place them in the trenches and block them in position using wet compacted sand if necessary. During this operation, check that the cradles are level, straight, aligned and parallel. Fill the trenches using wet compacted sand.

Important! Take care to respect the correct excavation depth for the cradles corresponding to your pool.

RECOMMENDATIONS AND ADVICE:

- Before beginning assembly, identify the various slat types with reference to the exploded view at the end of this document.
- Establish the final orientation of your pool, the skimmer should be oriented facing into prevailing winds. The skimmer should be mounted on a side that starts with a type A slat.
- While assembling the walls, make sure that each slat is fully engaged before starting on the next.
- You may need to use a hammer and a clamp to remedy any slight warping of the slats. Do not strike the wood directly, use the protective brace (provided).
- During assembly, check regularly that the walls are level and the 4 diagonals are equal in length.
- To avoid the risk of injury or damage to the liner, take care to eliminate any splinters during and after assembly.
- Please refer to the various illustrations provided in this document.
- If you intend to fit your pool with a counter swim treadmill, you will need to incorporate the 2 slats specially prepared to mount this option.

DIAGRAM

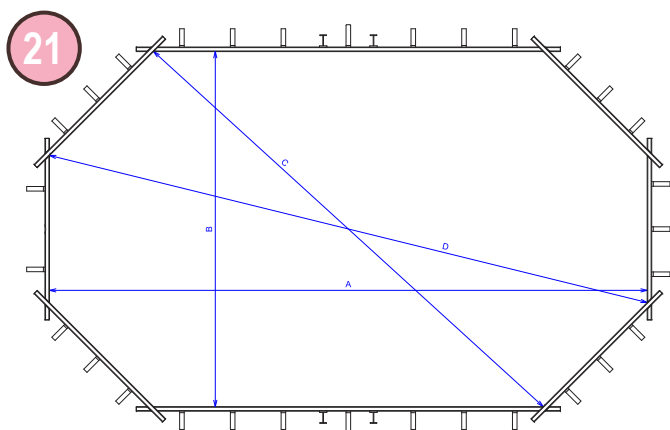

OVERVIEW				
	A	B	C	C
+540	4.88	2.78	4.28	5.01
+510	4.59	3.02	4.28	4.81

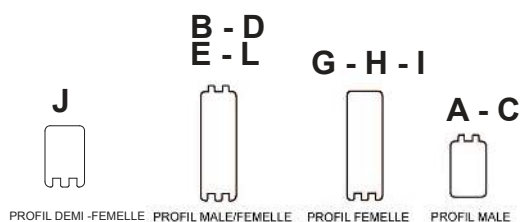

+510 pools

Fit together the two type A half slats and the two type C half slats and the 4 type L slats as shown in the diagram, with the male side (tongue side) facing up.

+540 pools

Fit together the two type A half slats and the two type C half slats and the 4 type B slats as shown in the diagram, with the male side (tongue side) facing up.

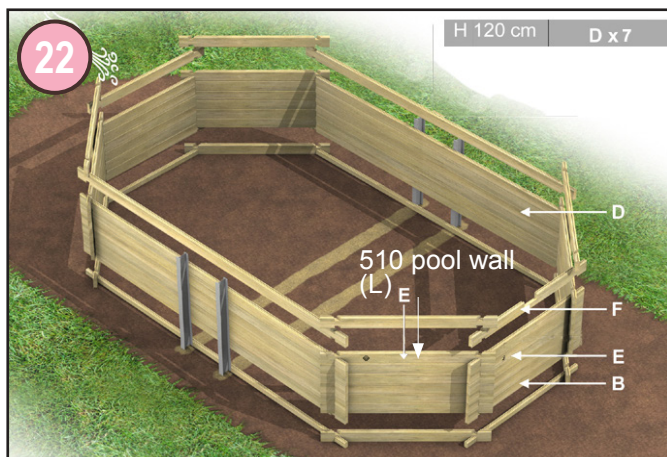

Fit the remaining slats together using type B slats on the short sides and type D slats on the long walls. Take care to correctly position the pierced slats (type E) that will hold the return and vacuum fittings, the machined slat (type F). (Refer to the exploded view at the end of this document for the position of these slats). The slat that will hold the return fitting (E) should be positioned above 4 type B slats + 1 type A slat. The type F slat should be located above the return fitting slat in the last row at this point in the assembly procedure.

For the +510 model, the oblique sides are comprised of type L slats, see the diagram above.

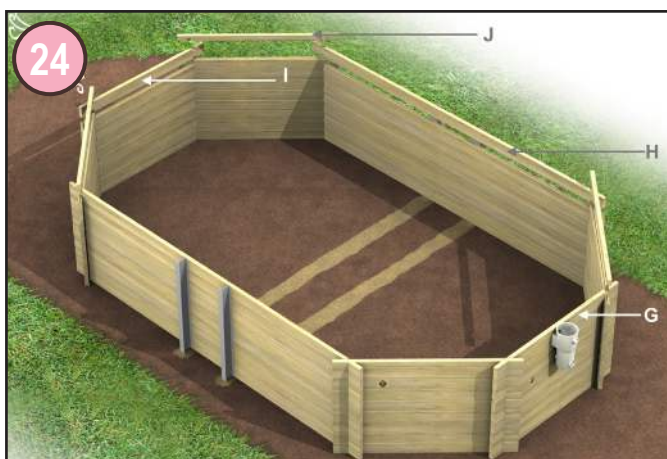

At this point, fit the skimmer into the machined slat (F). Slot the top skimmer slat (G) over slat F and continue around the pool, fitting 2 type H slats, 1 type I slat and 4 type J half-slats into position as shown.

Paint the ends of the slats in the corners with a wood stabiliser to limit deformation over time. This product is white on application, but becomes colourless when dry. Drying time is 2 to 3 hours. Apply a second layer if the temperature is high or if the product dries too quickly. Follow the safety instructions printed on the container. Rinse the brush after use.

IMPORTANT

The structural dimensions and measurements listed have a tolerance of +/- 3% (European standard EN 16582-1). The AFNOR AC P90-321 agreement allows the following deviation in terms of depth:

- For a depth less than or equal to 25m : +/-3cm
- For a depth greater than 1.25m and less than or equal to 1.65m : +/-5cm
- For a depth greater than 1.65m : +/-8cm

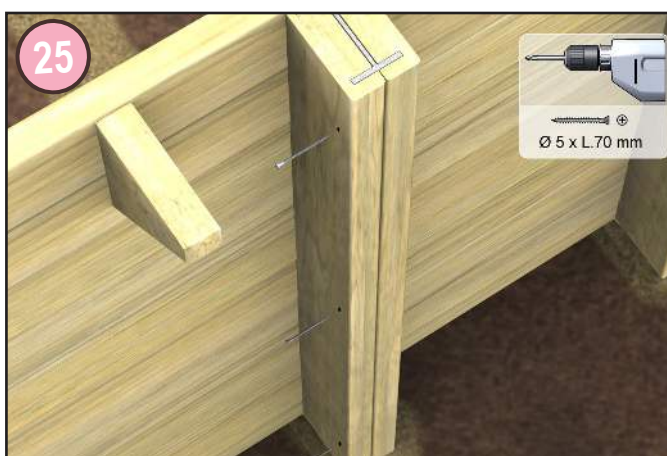

Working from the outside, fasten the cradle's vertical posts (pre-drilled) onto the wooden walls using 6x30mm screws from bag S. Check their verticality. Position two decorative profiles (Q) on either side of each post and fasten them together using 3 5x70 screws (bag S) as shown.



The wooden corbels will support the coping that will be mounted after the pool is filled. Pre-drill the wall from inside the pool then attach each wooden bracket (type L) using 2 screws (5x80mm sachet R) taking care to position them flush with the top of the structure. Remove any splinters that may have been raised during this process.

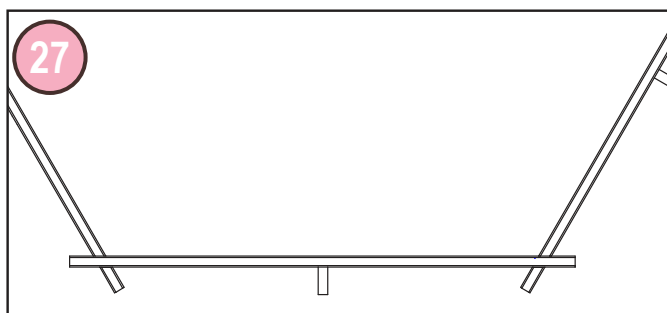

There is 1 wooden corbel per side (except the side holding the skimmer). Centre the corbel.

MODEL	D IN CM
+450 / + 540	60
+510 / + 640	75

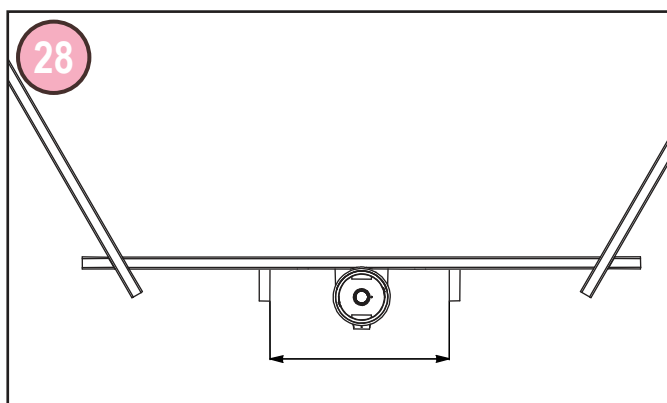

Mount 2 wooden brackets on the wall holding the skimmer, they should be positioned equidistant from the skimmer axis. The distance between the 2 brackets varies depending on the pool model, see the table below.

Paint the ends of the slats in the corners with a wood stabiliser to limit deformation over time. This product is white on application, but becomes colourless when dry. Drying time is 2 to 3 hours. Apply a second layer if the temperature is high or if the product dries too quickly. Follow the safety instructions printed on the container. Rinse the brush after use.



Mount a decorative profile (type H) on the end of each wall using nails (3.1x75mm) inserted through evenly spaced holes pre-drilled along the axis of the profile.

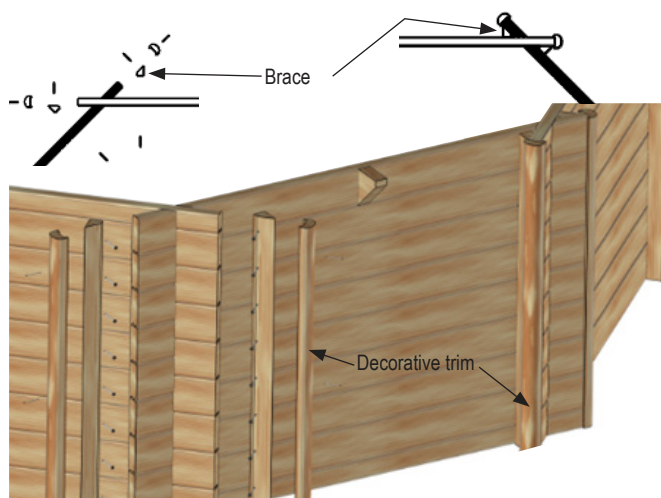

To attach the brace from the outside: locate the screws 100mm from the corner. Use one screw per slat.

To attach the brace from the inside: Locate the screws 85mm from the corner. Use one screw per slat.

Paint the ends of the slats in all the corners with a wood stabiliser to prevent deformation over time.

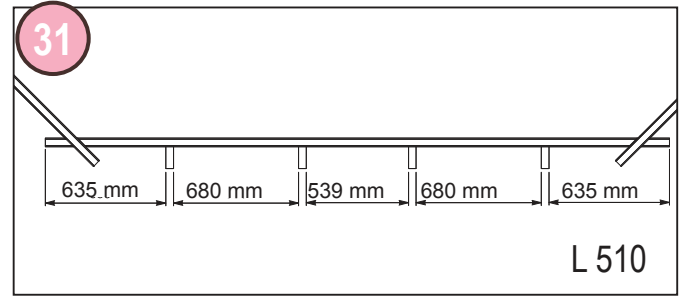
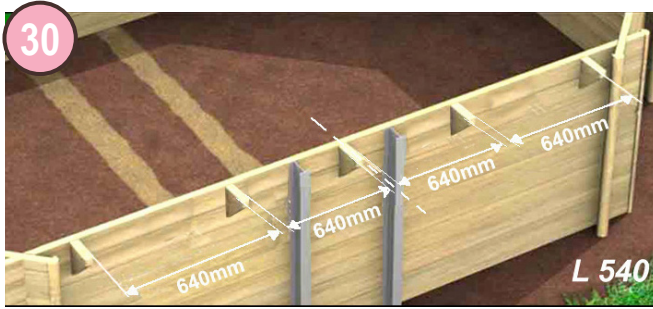

Mount the wooden corbels along the lengths as shown.

CAUTION

Once the structure has been assembled, the liner must be fitted and the pool must be filled with water within at most 5 days. Past this time limit, the structure will need to be carefully inspected to ensure the absence of any deformation (movement of the slats, shrinkage, etc.) that could impact the structural integrity of the work. In the event that gaps appear between the slats, reengage the slats properly before fitting the liner.

10. MOUNTING THE LINER LOCKING TRACK & FITTING THE UNDERLAY



IMPORTANT !

Check that the structure is correctly assembled before mounting the liner locking track..

To do this:

- use a spirit level to check that the structure is horizontal around the entire periphery.
- check that the 4 diagonals are equal in length..

Fix any imperfections before continuing.

The liner locking track should be flush with the top of the wooden structure.

Before mounting the liner locking track, pre-drill using a \varnothing 3mm drill bit.

Avoid over tightening, this could cause the screws to

break through the track.

Each side of the pool is fitted with one track 1.18 m long and another track trimmed to fit, see the table below.

Trim 8 tracks according to the table below. Before making the cuts, check that the total length of the track is equal to the length of the wall less 10 cm. Use a mitre box to ensure that the cuts are clean and straight. Deburr the cuts using the fine grain file.

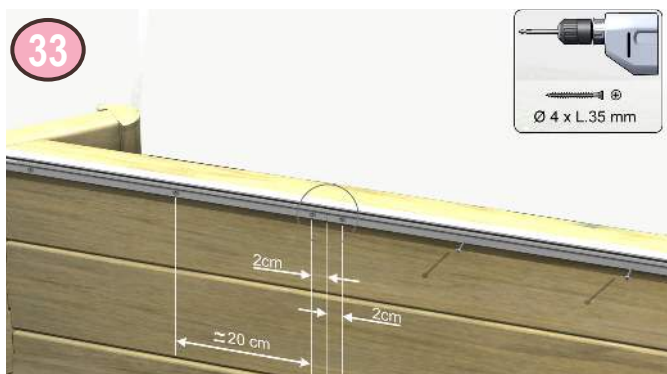

Hold the track in position using a screw placed 2 cm from each end. Then complete attachment of the track by inserting screws at 20 cm intervals. (Use \varnothing 4 x 35 screws -sachet D).

POOL MODEL	SHORT SIDE	OBLIQUE SIDE	LONG SIDE
Octo +510	1.18+0.26	1.14	1.18+1.18+0.57
Octo +540	1.14	-	1.18+1.18+0.88

HOTLINE 0 892 686 970 Service 0,60 € / min + prix appel



IMPORTANT

The ground underneath the underlay should be absolutely flat and free of any bumps or rough areas that could damage the liner. Because of the pressure exerted by the water, even the smallest bump will be visible underneath the liner.

After clearing the ground, spread a layer of sand mixed with cement (1 part cement to 7 parts sand) over the floor of the pool and compact it. This layer should be no more than 1 cm deep. (The sand and cement are not supplied). Unfold the underlay in the pool taking care to line it up correctly with the corners. Smooth out any wrinkles.

11. POOL FITTING GASKETS



Before fitting the liner, glue one of the 2 rectangular self-adhesive gaskets (pool fitting skin pack) around the mouth of the skimmer or filtration unit.

Make sure that the holes in the gasket are correctly aligned with the holes in the skimmer or filtration unit.



From the pool side, insert return fitting throughwall flange (pool fitting pack) into the opening in the machined slats.

Fix it in position using countersunk self-tapping 3x25 screws.

Fit a self-adhesive gasket to each throughwall flange. Screw carefully by hand to avoid damaging the wood.

12. FITTING & CUTTING OUT THE LINER

IMPORTANT

The ideal temperature for laying liner is between 18° and 25°C. Outside this range, the liner will be either too rigid or too pliant and will be difficult to fit. On very hot days, lay the liner early in the morning. During cold weather (less than 18°C), store the liner somewhere warm for as long as possible to increase its suppleness and do not take it out until the last minute.

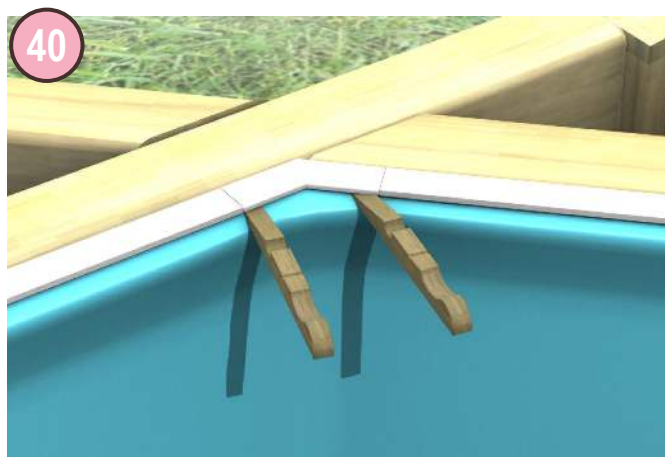
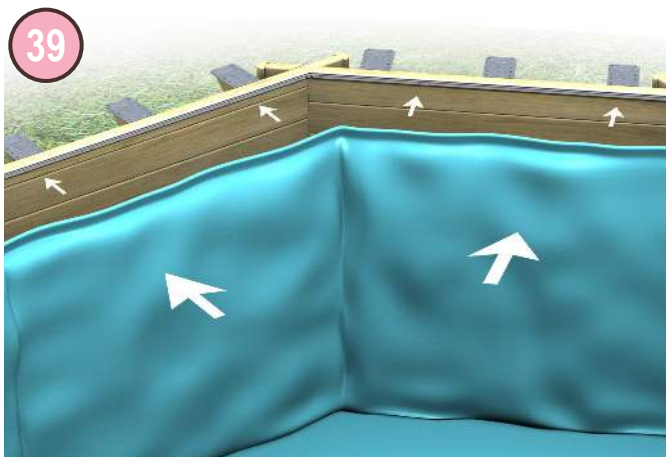

Place the liner in the centre of the pool and unfold it. When it is unfolded, the liner will form either an octagon, an elongated octagon or a hexagon on the ground, depending on the pool model. Line the corners up with the corners of the pool structure. Working in bare feet from inside the pool, fit the liner lip into the liner locking track, continue around the pool.

CAUTION

The vertical seam that joins the band that covers the walls should not be on the wall that holds the skimmer. If this is the case, rotate the liner.

While fitting the liner, insert wooden half pegs (provided) in the liner locking track to hold it in position in the corners and at regular intervals around the periphery. This will help position the liner and stop it from slipping in the track. Keep the pegs in position until the pool has been filled with water.

Make sure that the bottom corners of the liner correspond to the corners of the pool structure. You will note that the liner is slightly smaller than the structure, this is normal and necessary to ensure correct tension on the liner after the pool has been filled with water. Reductions are approx 1% around the periphery and 5% along the height. Make sure that the liner is spread out over the entire surface of the pool.

Leave the liner as is until the warmth of the sun eases out the creases caused by folding (this will take a few hours).

CAUTION

In the event that you need to move the liner, do not slide it in the track.

Take it out of the track by pulling upwards on the lip and reposition it. Sliding the liner in the track can cause it to tear just below the lip (this type of damage will not be covered by any guarantee).

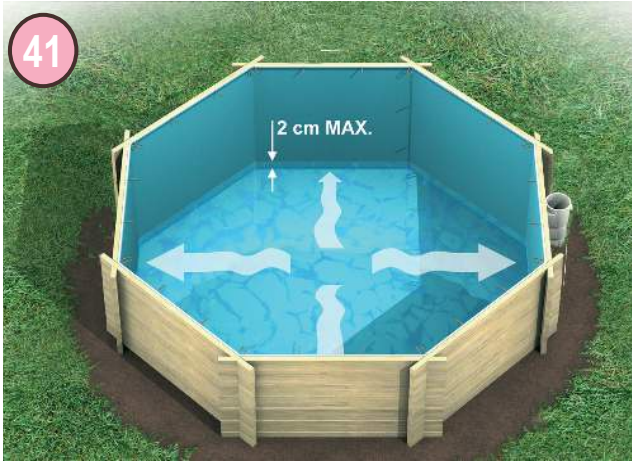

Once the liner has been hung and is correctly positioned, fill the pool with 2 cm of water. Push any creases towards the walls smoothing out the liner as much as possible. Take care to ensure that the floor is as smooth as possible. This operation will not be possible if the pool is empty or overfilled (contains more than 2 cm of water).

Stick the self-adhesive gaskets to the return fitting and vacuum fitting flanges. Locate the holes in the throughwall flange and mark them.

Screw the flange (fitted with its gasket) into place using the countersunk SS screws M5x16 from the pool fitting skin pack. Tighten the screws alternately to

ensure a leaktight fit. Hand tighten, over tightening could damage the flange.



Stick the self-adhesive gaskets to the return fitting and vacuum fitting flanges..



Locate the holes in the throughwall flange and mark them.

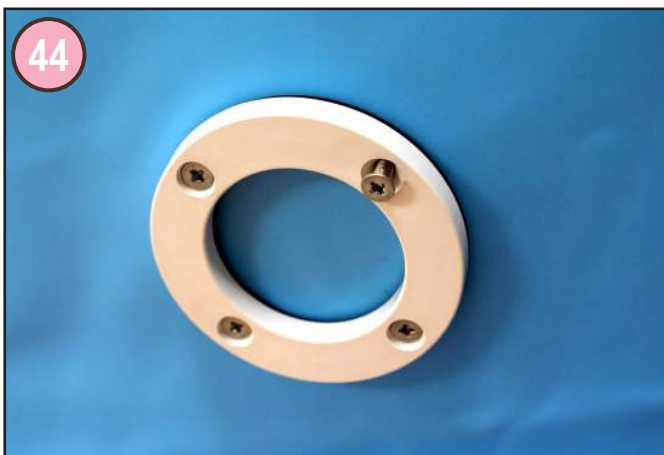

Screw the flange (fitted with its gasket) into place using the countersunk SS screws M5x16 from the pool fitting skin pack. Tighten the screws alternately to ensure a leaktight fit. Hand tighten, over tightening could damage the flange.

Cut out the return fitting.

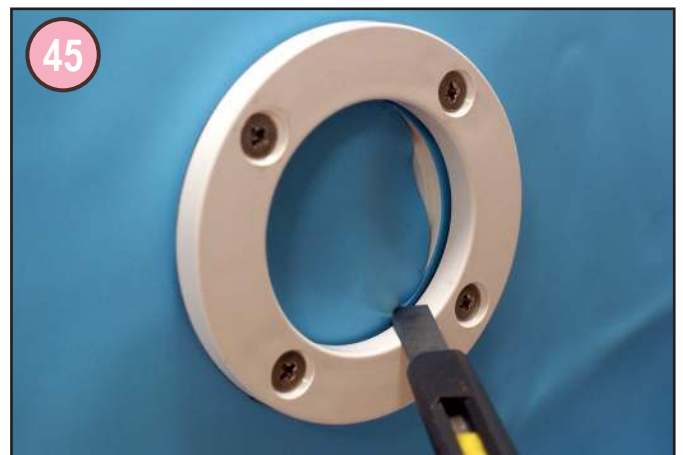

Using a Stanley knife, carefully cut the liner following the inside of the return fitting.

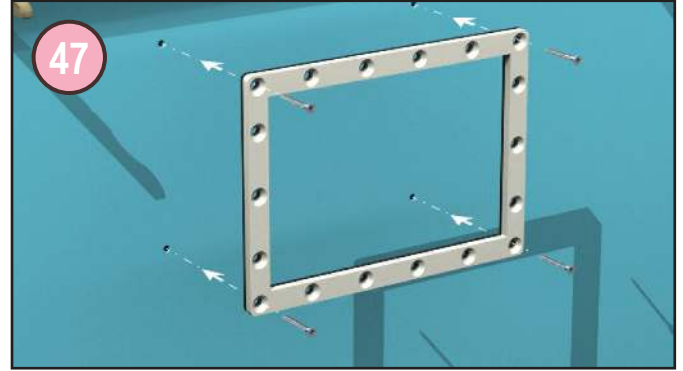
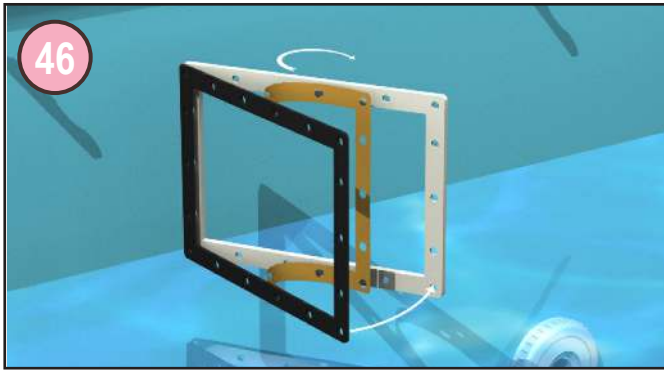

Glue the second skimmer gasket to the interior surface of the skimmer flange. (The interior surface has sharp edges while the exterior surface has rounded edge).

Locate the 4 corner holes of the skimmer mouth and mark them with a pen.

Position the flange such that its corner holes are aligned with the points marked in pen..

Use a small screw driver or punch to pierce the liner at the 4 points marked and fix the flange in position with the gasket against the liner. Once the 4 corner screws are in place, continue, inserting a screw through each hole. Avoid over tightening, this could deform the flange. Tighten the screws alternately to ensure an even and leaktight fit.

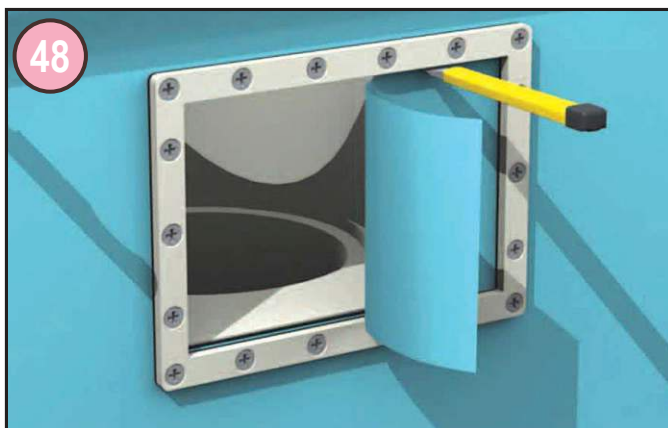

Cut away the liner inside the flange. Keep the offcuts for future repairs.

Clip the weir into place, smooth surface facing the pool. The weir should be able to swing freely.

Mount the skimmer face plate.

The skimmer basket is passed through the skimmer mouth, swing the weir towards the pool to make space.

Place the lid on the skimmer. (these parts can be found in the Pool Fitting skin pack)

In the case of a filtration unit, refer to the installation instructions enclosed with it.



Screw the multi- directional eyeball assembly into the return fitting body. The eyeball should be pointed left to facilitate the flow of water necessary for efficient filtration.

(Prior to assembly, apply a layer of silicon grease to the eyeball and its housing to facilitate its movement and subsequent removal).

13. ASSEMBLING AND COMMISSIONING THE FILTER GROUP

Before you continue to fill the pool, assemble the filtration group. Refer to the sand filter installation instructions below and the pump operating instructions. Study the filtration system diagram and the table below that lists the main components and the composition of the various packs.

CAUTION

The pump power supply absolutely must be protected by a 30 mA RCD mounted upstream from the installation.

Similarly, follow all the installation instructions set out in the manuals enclosed with the underwater light and the electrical panel.

The filtration system, like every other electrical device, must be wired in accordance with the standards in effect in the country of installation (C15-100 in France).

Do not hesitate to call on the services of a professional to ensure that your installation complies with all regulation in effect..

We strongly recommend that you install the filter below the water level. If the filter is installed above the water line, there is a risk of deformation due to depressurisation. The maximum acceptable height is level with the coping. In the event that the filter is installed above the water line, a check vent must be mounted on the return line and an inspection check valve must be mounted on the suction line (these items are available from any pool specialist).

13.1 Filtration components components and specifications

Description	Flow rate m ³ /h with directional jet in the return fitting	Pump	Filter diameter in mm	Sand	Filtration surface area m ²	Volume filtered in 24h
TROPIC filtration	5.37	Aqua-tropic 4m	400	1 x 25 kg	0.125	128.9
Ref	Description	Ref	Description			
B	Floating hose D38 mm	L	Pressure gauge			
D	Rubber sleeve + circlips	O	Return fitting jet assembly			
E	Pump/filter connection hose	O1	Return fitting body			
G	Pump	O2	Return fitting gasket			
I	Skimmer assembly	O3	Return fitting flange			
I1	Skimmer assembly	O4	Directional jet return fitting face plate			
I2	Skimmer basket	P	Drain plug + o-ring			
I3	Skimmer gasket	Q	Collector pipe with cap			
I4	Skimmer screw 5.5 x 25	R	Collector plate			
I5	Skimmer flange	S	Lid			
I6	Skimmer weir	V	Lid holding ring			
I7	Skimmer face trim	W	Lid holding ring o-ring			
I8	Skimmer body	X	Diffuser			
J	Union under the skimmer	Z	Filter tank			

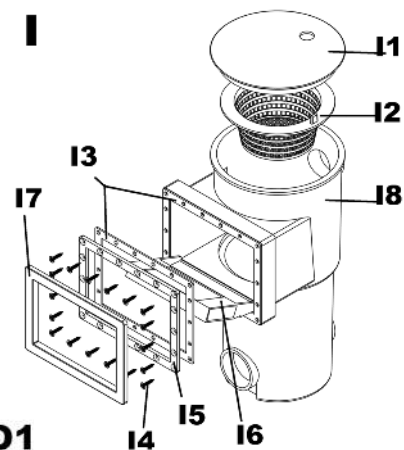
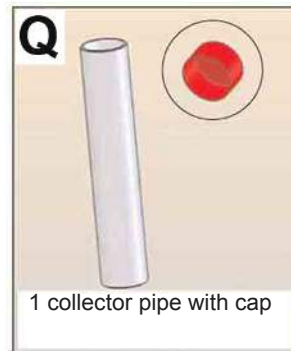
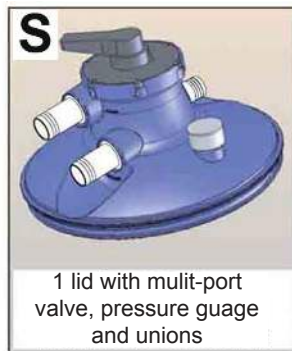

13.2 Assembling the filter



50 Check that the drain plug and o-ring are in position. Hand tighten only.

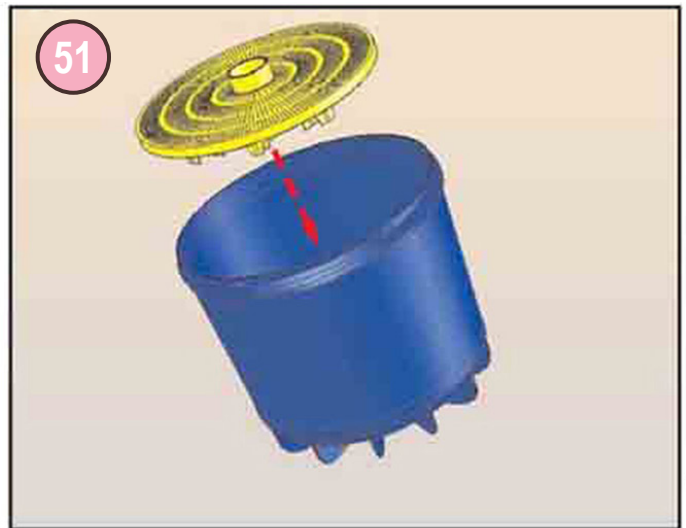

51 Place the collector plate in the base of the filter tank. Check that it is flat.

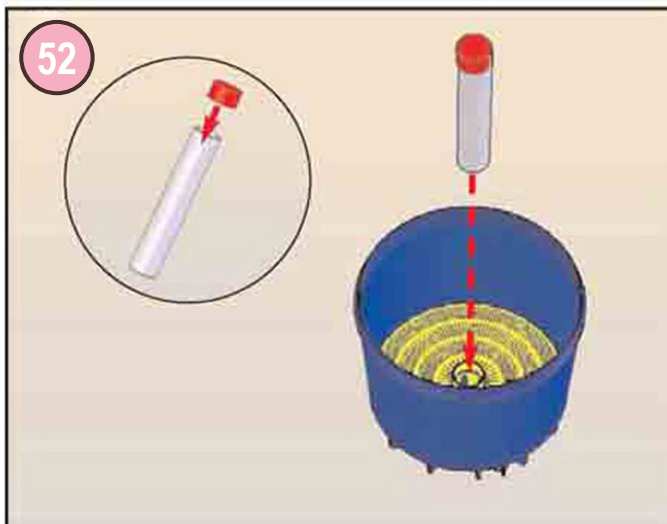

52 Place the cap on the collector pipe and insert it into the hole in the middle of the collector plate. Pour the sand filter medium carefully into the tank, use your hand to spread it out evenly.

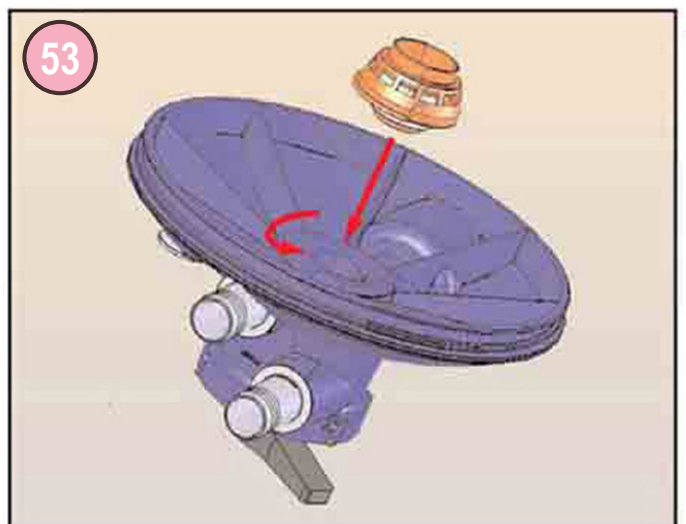

53 Insert the diffuser into the lid and rotate it anti-clockwise to lock it in position.



Installing the pressure gauge: Place the o-ring in its groove in the cover.



Position the pressure gauge correctly and place it in its housing.

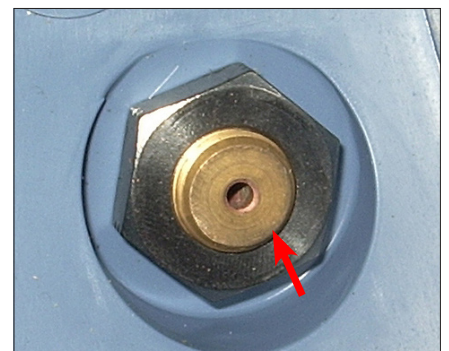

Working from underneath the cover, tighten the bronze nut by hand, then moderately using a 22 tube wrench. Take care not to damage the o-ring.

The filter lid features 3 ports. Mount the relevant union on each port:

Port on the lid	Union to be mounted
Waste	Hose tail, 38 mm
Suction	Hose tail, 45 mm
Return	Tapped sleeve 1"1/2 x male, solvent, 50 mm.

! The sand should reach 2/3 of the way up the filter.

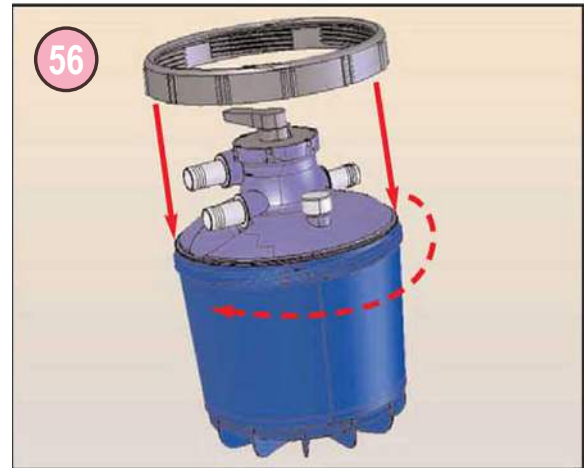
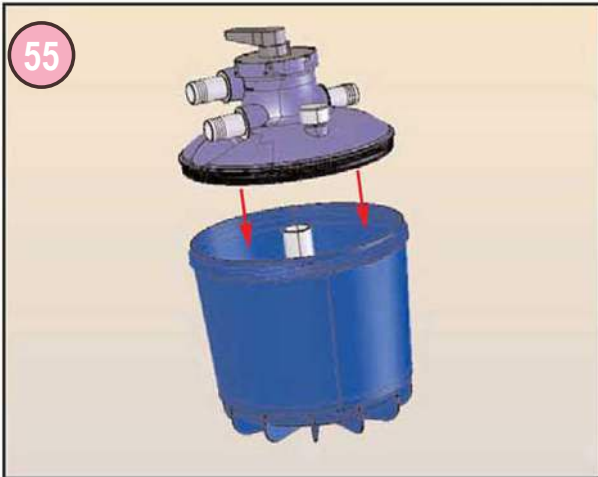

Check that the upper, inner section of the tank is clean.

Remove the cap from the collector pipe.
Apply a lubricant (silicon grease) around the top of the inside of the tank if necessary to facilitate fitting of the lid.

Lay the lid flat on the tank and press down evenly on the lid to insert it into the tank.

Once it is properly fitted the lid should touch the top of the tank and the o-ring should not be visible.

Put the lid ring into position to hold the lid on the tank.

Rotate one quarter turn by hand only.

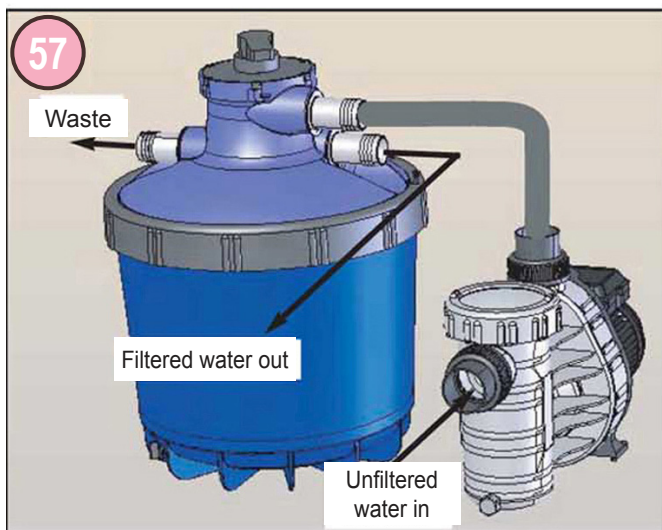

! An improperly fitted lid could lead to:

- Sand being introduced into the pool through the return fitting
- Water flowing through the waste port.
- Water leaks on the tank.
- It is normal for a small amount of water to flow from the waste port in filtration mode.

13.3 Skimmer and return fitting connections



Wrap Teflon (not provided) 3 times around the threading of the hose tail before screwing it onto the body of the skimmer. Fit the pump suction line onto the skimmer hose tail and fix it in position using a circlips.



Fit the filter return line onto the return fitting hose tail and fix it in position using a circlips.

13.4 Pump filter & collector module



Assemble the pump. Orient the assembly to facilitate subsequent connection of the semi-rigid pipes leading to the pool.

Mount the screwed union onto the pump outlet (do not forget the o-ring).

Connect the hose as illustrated, between the pump outlet and the 6-way multi-port valve

13.5 Pipe connections

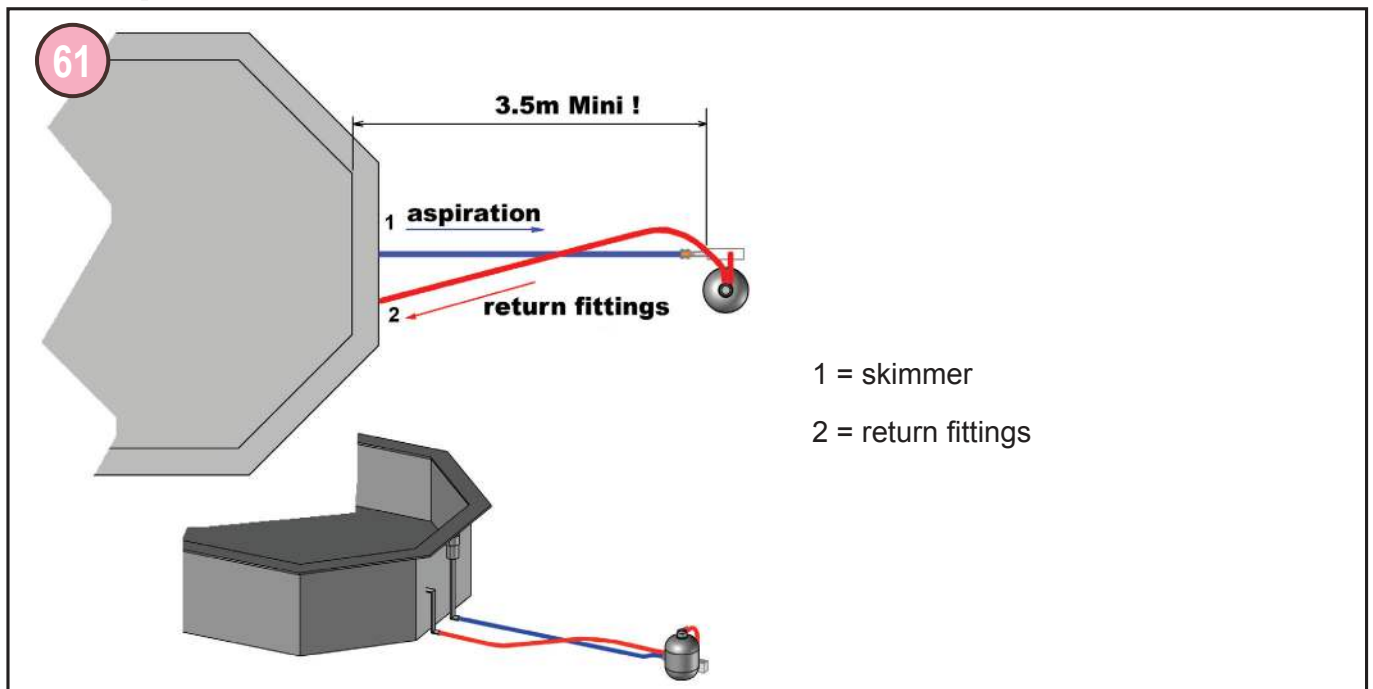

Connect the rigid descending pipes to the filtration group as shown above. The roll of tubing provided in the Filtration kit is sized for a standard installation, that is to say, with the filter group located 3.5 m from the pool (minimum distance between the pump and the pool according to the French electrical safety standard C15-100 if the filtration group is not installed in a locked plant room).

Tip:

You may use silicon grease or soapy water to help fit the pipes together.

14. FITTING THE COPING

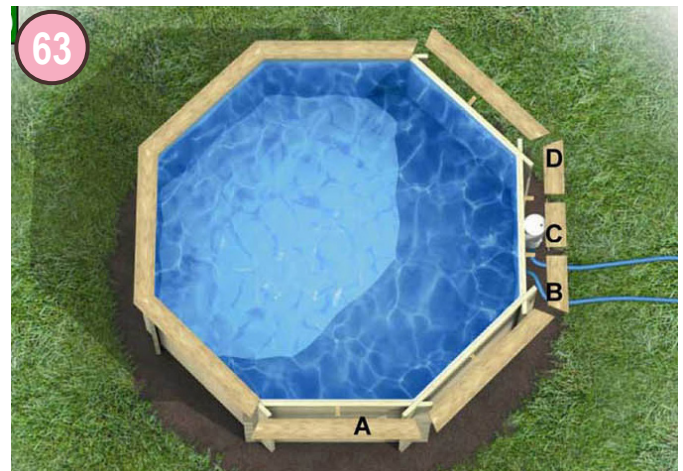
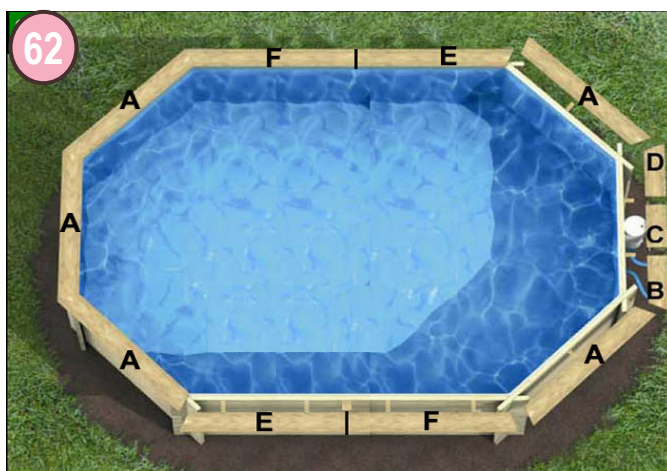

Note the distribution of the various modules constituting the coping on the drawing. Arrange them on the coping support brackets. Make sure that the elements are correctly and evenly positioned around the entire periphery of the pool. Adjust them if necessary and make sure that they remain in position until screwed in.

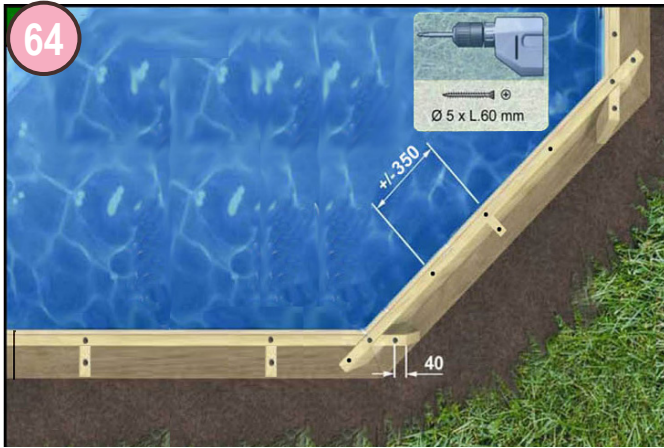

Attach the 7 coping planks of the same length. Be careful to drive the screws into the centre of the wooden walls to avoid damaging them. (screws from bag T or Q)

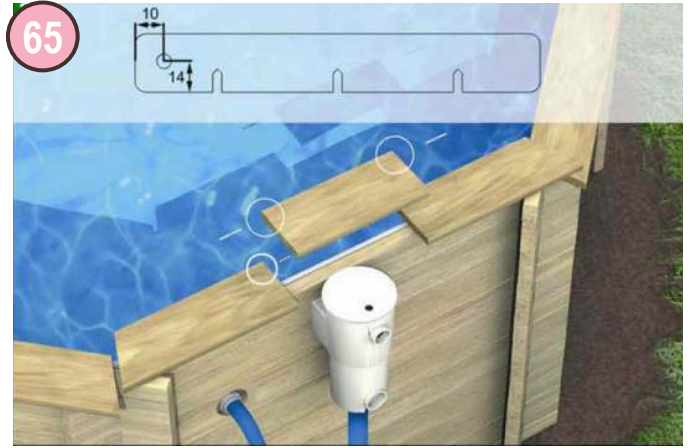

Before fastening the 3 parts of the coping over skimmer in position, pre-drill the central element and the two side elements at the points indicated above. Make sure that the holes (6mm) are drilled very precisely and that they are properly aligned. Insert the pivots (bag ref 27511070), then replace the coping elements..

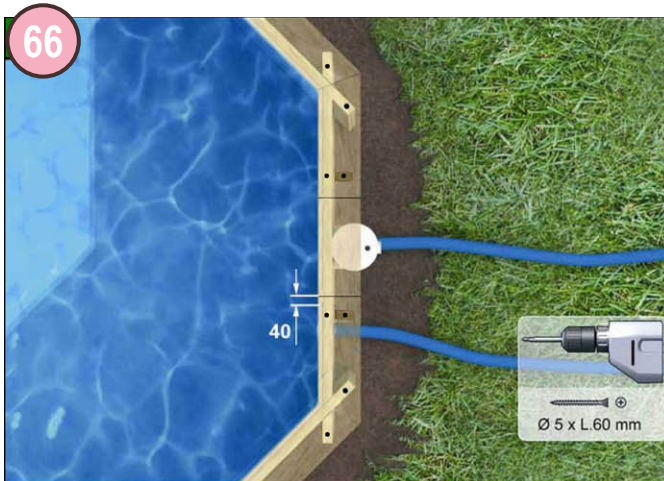

Screw the two side elements in position as shown..



All that remains is to attach the 8 coping corner connecting brackets (bag 27511671) as shown above, taking care to position the brackets correctly..

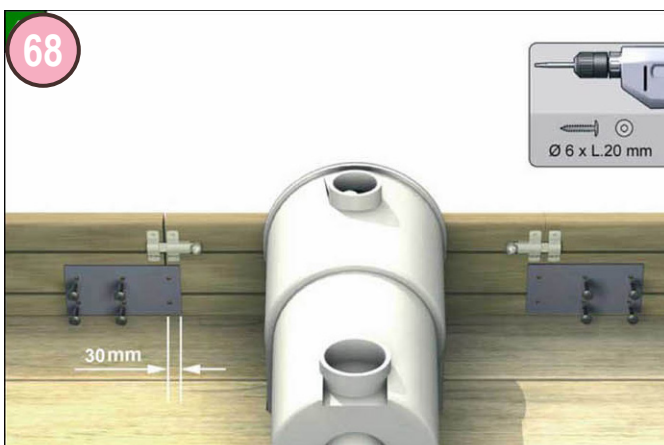

Study the illustration above. Mount the brackets (identical to the connecting brackets) as shown using screws (bag M).

Next, fasten the latches into position (use the items from bag N) to ensure effective locking.

15. ASSEMBLING AND INSTALLING THE STAINLESS STEEL LADDER

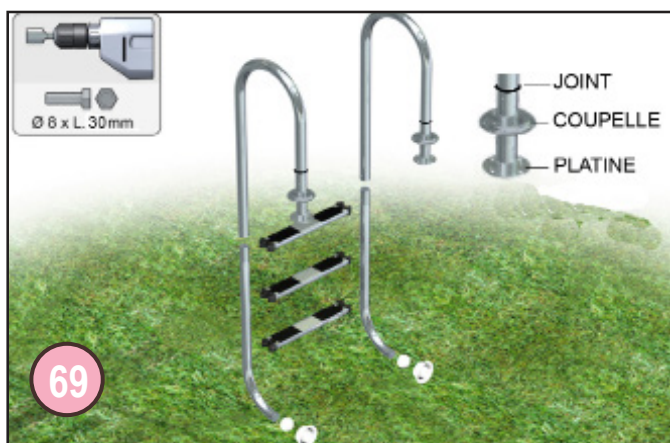

Assemble the various parts of the ladder referring to the installation instructions provided.

When mounting the hand rails, do not forget the two rubber seals that will be used to hold the decorative escutcheon plates in position

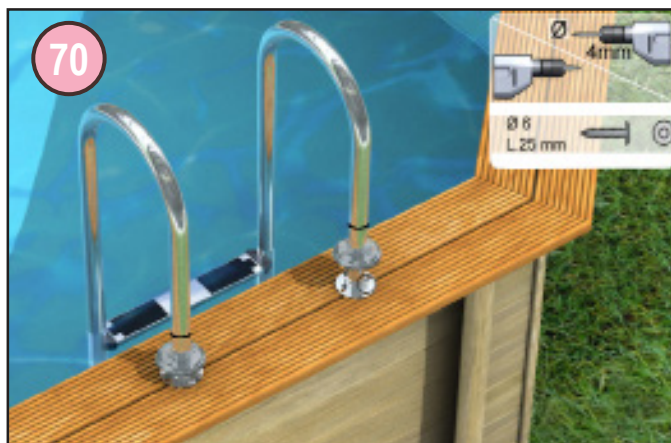

Position the ladder in the pool on the coping module of your choice (except the wall holding the skimmer and counter swim module), remember that it should be opposite the wooden ladder.

Adjust the position of the ladder paying particular attention to ensure that it is vertical and that the bumpers are pressed firmly against the inside wall. Mark the positions for drilling. Remove the ladder and drill.

Fix the ladder in place according to the instructions provided using SS screws from bag B. Slide the 2 rubber seals along the tubes so that they hold the escutcheon plates in position.

16. ASSEMBLING AND INSTALLING THE WOODEN LADDER



The stringers and the treads for the wooden steps are in the Wood kit. Assemble the wooden steps using the SS screws (bag K). For cleaner, more efficient assembly, we recommend that you pre-drill the various elements (4 mm drill bit) and mill the holes to avoid splitting the wood and raising splinters.

Make sure that all elements are oriented correctly..



The wooden ladder is fitted with two lever latches that lock it into position. The lever sections are fitted to the ladder supports and the hooks are mounted under the coping (these parts are enclosed in bag K). Observe how these 2 parts interact together to understand how the mechanism works and establish the travel necessary for the ladder to be locked correctly into position.

Position the assembled ladder under the coping. Insert the blocking parts between the wooden supports and the coping. These should be positioned in line with the lever latches. Trace the position of the various elements. Remove the ladder, screw the blocking parts into position and attach the lever elements to the ladder supports. Put the ladder in place and lock it in position.

The locking mechanism might differ from that illustrated here, but will function according to the same principal.



FOR YOUR CHILDRENS' SAFETY!

Don't forget to stick the safety instructions to the pool wall to the pool wall stating **UNSUPERVISED YOUR CHILD IS IN DANGER.**

On the ladder stringer place the warning **ASSEMBLY DISASSEMBLY DIAGRAM. REMOVED=SAFE**

These notices should be nailed into position.



17. FILLING AND CHARGING THE CIRCUIT WITH WATER

17.1 Filling the pool

Check that all the valves are closed and continue to fill the pool until the water level is 2/3 of the way up the mouth of the skimmer. This is the optimum level for correct filter operation.

While filling, check the various fittings for leaks. Make sure that the liner is properly engaged in the liner locking track around the entire periphery of the pool, particularly in the corners. If the liner has come away it will usually be necessary to empty the pool in order to reattach it.

17.2 Filling the circuit with water

Check the various connection points for leaks.

Make sure that the pump is filled with water before starting it up. The pump should under no circumstances be allowed to run dry. Make sure that the pre-filter is filled with water. If necessary, open the pump and fill it and the skimmer line with water to facilitate priming.

Turn the 6-way valve to Backwash (to carry out a filter backwash before putting the filter into service).

Start the pump and check again for leaks.

17.3 Commissioning & operating the filtration system

17.3.1 Commissioning and operating recommendations



WARNING

Carry out a back wash and rinse before using the filter for the first time to clean the filter and remove any excess sand and debris (see the paragraph Filter and Valve operation). After the backwash, rinse before turning the valve to the Filtration position. After the backwash, with the multi-port valve set to Filtration, the black needle on the pressure gauge indicates the nominal pressure experienced by the filter. This pressure will vary as a function of the pump flow rate, the static pressure and load losses across the pipes. To keep a record of this nominal pressure (calibration), adjust the dial of the pressure gauge so that the blue needle aligns with the black needle.

NB Stop the pump before each manipulation of the 6-way valve. Failure to respect this instruction will result in damage to the filter, the valve and pump and cancellation of the guarantee.

17.3.2 Filter and valve operation

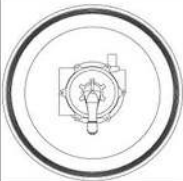
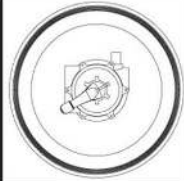
- **FILTRATION:** Water arrives from the pump, passes from the top to the bottom of the filter and is returned to the pool.
- **BACKWASH:** Water passes through the filter from the bottom to the top gathering trapped impurities and carrying them directly to waste. Backwash should be carried out as soon as the needle in the pressure gauge enters the red..
- **RINSE:** Water passes through the filter from top to bottom before being directed to waste (allow approx 30 sec for this process to evacuate dirty water in the pipes).
- **CIRCULATION:** Water circulates without passing through the filter.
- **DRAIN:** Water passes from the pool to waste (flocculation, etc.).
- **CLOSED:** No water circulation. Never allow the pump to run while the valve is in this position. Similarly, make sure that the position of the various valves will allow circulation of water before turning the pump on.

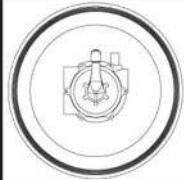
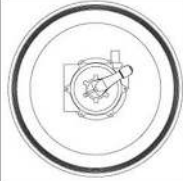
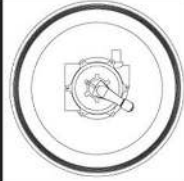
<p>FILTRATION : Position habituelle de la vanne. L'eau venant de la pompe traverse le filtre de haut en bas et retourne à la piscine.</p>		<p>VIDANGE : L'eau venant de la pompe va directement à la vidange sans passer par le filtre.</p>	
<p>FERMÉ : Aucune circulation n'est possible. Veiller à ce que la pompe ne fonctionne jamais dans cette position.</p>		<p>LAVAGE : L'eau venant de la pompe traverse le filtre de bas en haut, puis part à la vidange entraînant avec elle les impuretés retenues par le filtre.</p>	
<p>CIRCULATION : L'eau venant de la pompe retourne directement à la piscine sans passer par le filtre.</p>		<p>RINÇAGE : L'eau venant de la pompe traverse le filtre de haut en bas et part vers la vidange.</p>	

17.3.3 Length of the filtration cycle

The length of the filtration cycle depends on the theoretical time taken for all the water in the pool to pass through the filter. For private pools, the max time allowed for all the water to be recycled is 8 hours.

We recommend the following as a function of water temperature:

- Below 14°C : 5 to 6 hours per day.
- From 15° to 23 °C : 6 to 8 hours per day.
- Above 23 °C : 10 to 12 hours per day.

The higher the bather load and the pool water temperature, the longer the filtration cycle should be. To optimise filtration efficiency, run the filter during the day (between 8:00 am and 9:00 pm) and, more generally, while the pool is in use (one bather pollutes 3 m³ of water).

17.3.4 Cleaning the pre-filter and backwashing

PRE-FILTER

After a certain time, a drop in the flow rate at the return fittings will be noted. This is due to progressive clogging of the filter or pump prefilter..=

If the pressure indicated on the pressure gauge falls below the nominal pressure indicated by the blue needle, clean the pump pre-filter:

- Stop the pump.
- Turn the 6-way valve to CLOSED.
- Close the suction and return valves.
- Open the pump pre-filter.
- Remove the basket.
- Use a water jet to remove any impurities.
- Put the pre-filter basket back.
- Put the pre-filter lid back on making sure that the seal is correctly positioned and that there is enough water to prime the pump.
- Put the 6-way valve to FILTRATION.
- Open the suction and return valves.
- Switch the pump on.
- Vent the filter (this should be done each time the pre-filter is cleaned and at least once a week).).

FILTER

If the pressure indicated by the pressure gauge rise above the nominal pressure, carry out a filter back wash.

- Stop the pump.
- Check the pre-filter and clean it out if necessary (as indicated above).
- Before proceeding with a filter back wash or draining the pool, make sure that the waste pipe (not provided) has been attached to the waste outlet.
- Put the 6-way multi port valve to "Backwash"
- Switch the pump on.
- Observe the colour of the water in the sight glass.

Caution! It will take a few seconds for cleaning to commence and the water to become cloudy..

- As soon as the water runs clear, stop the pump.
- Turn the 6-way valve to "Rinse"
- Run the pump for 20 to 30 seconds, this will evacuate any impurities remaining in the valve and stabilise the sand.
- Stop the pump.
- Turn the 6-way valve to "Filtration".
- Turn the pump back on.

After a back wash, the pressure needle should align with the nominal pressure indicator.

18. MAINTENANCE AND USE

Wood is a living material that responds to changes in temperature and humidity; cracks and splits may appear; this is natural and in no way impacts the service life of our products.

The wooden components of this pool are subjected to a Class IV autoclave treatment that complies with standards in effect, they present no danger to people or animals that may come into direct contact with the wood.

Do not apply any product to the wood (for example: lazure, micro-porous products, etc.)

Over time, the wood will inevitably get dirty. Clean it once a year with a high pressure jet to remove dirt trapped in the pores of the wood. Take care to regulate the water pressure to avoid damaging the finish or raising wood fibres.

This pool is delivered as a kit and is not designed to be dismantled.

This pool is designed to be used by persons 3 years of age and older. It is understood that young children and non-swimmers using the pool will wear flotation devices. For your safety and that of your children, we recommend that you read and apply the safety recommendations on page 36.

Use of a pool kit implies adherence to safety recommendations outlined in the maintenance and operating instructions.

- octo 414 models
only 4 people allowed in the pool at one time.
- octo 505 model
only 5 people allowed in the pool at one time.
- octo+540 and +510 models
only 6 people allowed in the pool at one time.

Ladders should only be used to enter and exit the pool. Any other use is prohibited and could be dangerous.

The wooden access ladder should be taken away and stored systematically after the last person leaves the pool. This is to prevent the risk of drowning. We have designed a fast efficient locking system, use it!!

HOTLINE 0 892 686 970 Service 0,60 € / min
+ prix appel

Store the ladder in a dry place during the winter. There should be no means of access to the pool while it is not in use. The ladder wood should be treated in the same way as the other wooden elements.

We recommend that you secure access to the finished pool with one of the measures set out in the French pool safety standard NF P 90-306, 307, 308 & 309 that is: Safety barrier - Alarm - Safety cover - Shelter.

Inspect the accessible nuts and bolts regularly and carry out any maintenance required (re-tighten, treat traces of rust, etc.).

Take care with the liner of your pool, do not treat it roughly. Make sure that correct tension is maintained on the liner, failure to do so could result in tears and leaks. See the guarantee conditions at the end of these instructions.

During the life of your pool it may be necessary to empty it totally. In this event, take every precaution necessary to avoid accidents and danger (falls, etc.). Avoid leaving the pool empty for more than 48 hours, this could result in deformation of the structure.

REMINDER: NO DIVING - NO WALKING ON THE COPING - NEVER LEAVE AN EMPTY POOL UNCOVERED.

18.1 Water treatment

To ensure the comfort of pool users, you will need to treat the pool water. Follow the recommendations concerning operation of the filtration group: commissioning, frequency of use for regeneration of the water, maintenance, inspections (pipes, nuts and bolts), etc. Monitor the build up of dirt in the sand filter (see the section on filter back washing).

During the pool season, the filter should be run every day for long enough to renew the entire pool water volume at least three times every 24 hours.

To ensure optimal efficiency of the filtration system, make sure that the water level remains correct and constant. The water level should be 2/3 of the way up the skimmer mouth.

To fill your pool, use tap water, its pH is close to the ideal pH. If you use water from a well or some other private source you must have it analysed beforehand. You will need to test the pH of your pool at regular intervals and adjust it if necessary to keep it between 7.0 and 7.4. Treatment chemicals for this purpose are widely available.

To preserve the quality of the pool water, it will need to be tested and treated regularly. Frequency will depend on a number of conditions; pool situation, bather load, weather conditions, etc.

As pool water cannot be directed into the sewage system, it must be directed as rain run-off. Familiarise yourself with the regulations concerning disposal of pool waste water in effect in the area in which the pool is located.

Failure to abide by maintenance instructions may entail serious risks to health and safety, notably of children.

18.2 Accessories

Electrical equipment such as underwater lights that require an electrical supply must be fitted and wired in according to the standards in effect. We recommend that you take great care in this matter and that you call on the services of qualified specialists.

The pool can be fitted with a bubble cover that is spread over the pool while it is not in use. The action of sunlight on the cover heats the water below and the cover helps maintain the water temperature at night. Upon removing the cover from the pool, turn it over to allow it to dry, then roll it up and store it out of the way. Never fold the bubble cover, this could cause it to tear. Wipe it down from time to time with a damp cloth. This cover should under no circumstances be considered a safety device. A safety winter cover (that complies with the French safety standard NF P90-308) is available as an option to protect the pool. This high quality product is extremely hard-wearing and attractively finished. For storage and upkeep, follow the same instructions as for the bubble cover.

18.3 Winterizing the pool

Carry out a prolonged back wash of the filter.

The pool should not be emptied during winter (or prolonged periods while the pool is not use). The liquid mass plays a several roles, providing thermal insulation, holding the liner and pool structure in position.

Lower the water level to about 10 cm below the bottom of the skimmer mouth.

Water can be siphoned from the pool or allowed to drain by gravity by moving the multi port valve to DRAIN. Water will run through the waste line. Do not run the pump during this operation.

Next, disconnect the pipe underneath the skimmer so that it can act as an overflow in the event the water level rises due to precipitation. Remove any water treatment chemicals from the skimmer (chlorine tablets, flocculent, etc.).

Unscrew the return fitting face ring from inside the pool.

Use a threaded winterizing plug or rubber plug (not provided) to block the return fitting from inside the pool.

Add an algaecide and a winterizing product (not supplied) to the water.

Remove the stainless steel ladder.

Place a winter cover over the surface of the pool.

NOTE: Winterizing is not mandatory, especially if the weather is clement and temperatures remain positive. In this case, maintain a correct water level in the pool and run filtration 2 to 3 hours per day. Check the water level in the pool regularly.

18.4 Winterizing the hydraulic installation

Disconnect the return line.

Allow water to drain from the suction and return lines.

Open the plug at the bottom of the filter and allow water to drain away. Do not replace the plug before putting the filter back into service.

Open the drain plugs on the pump and pre-filter.

Leave the plugs open.

Cut the power supply to the filtration control panel.

In as far as possible, store the filtration group in a location protected from humidity. In the case of an unprotected outdoor installation, remove the pump and store it.

We think that we have provided you with main information you required to use and maintain your pool, however you will find more information in specialised guides and reviews. Don't hesitate to consult these.

18.5 Hygiene

As regards hygiene, there are no official regulations for family pools. However, for your health and that of your family and friends, there are some rules that you should respect!

This begins with good personal hygiene.

Next, to maintain water purity, respect the instructions set out in the section "maintenance and operation". Pay particular attention to treatment cycles, water testing, filtration and cleaning. The balance of your pool water depends mainly on you. Do not hesitate to inform yourself and follow the advice of the professionals.

19. SAFETY

19.1 Do not play with safety!!!

In this fun environment you need to watch your children! You alone are responsible for their safety ! Children should be closely supervised at all times. The risk is at its greatest when children are less than 5 years old.

- Accidents don't just happen to others. Be ready to act !!
- Never leave a child alone close to the pool.
- Children must be closely supervised at all times.
- Children who don't know how to swim, or children not supervised by adults, should wear a flotation device (vest or arm bands). Without these precautions, access to the pool should be strictly denied.
- The access ladder must be removed while the pool is not in use irrespective of the length of time for which the pool will not be used..
- Designate one person responsible for watching non-swimmers and children.
- Be particularly attentive when there are several people in the pool.
- Keep a pole and/or life ring close to the pool in case of necessity.
- Teach young children how to swim as early as possible!
- Before getting into the pool, wet the back of the neck, legs and arms to prevent irreversible thermal shock!
- This warning also applies to older pool users who frequently disregard this safety tip.
- Jumping or diving should be prohibited. The same applies to violent games.
- Do not stand or walk on the coping! No diving.
- Be careful not to leave toys in or around an unwatched pool, these could attract children...
- Keep the water clean and sanitary during the pool season.
- Water treatment chemicals should be kept out of reach of children; store them in a safe, inaccessible place. Never leave cleaning accessories near the pool.

Some equipment can enhance pool safety:

- safety barrier, with a gate that is always kept closed (for example, a hedge could not be considered a safety barrier).
- a manual or automatic safety cover correctly installed and fixed in position.
- a functional alarm to detect proximity to the pool or falls into the water.

Safety equipment will under no circumstances replace close surveillance.

- Outside the pool season, the pool should be covered with a winter cover correctly positioned and attached. This serves an additional function in that it renders the pool less attractive.
- Make sure that there is a telephone (land line or mobile) within easy reach of the pool to avoid leaving children alone in the event of a problem.
- Learn first aid, especially those techniques applicable to children, to provide assistance in the case of an accident.
- Take steps to prevent access to the pool if the filtration system is damaged and during maintenance operations.

19.2 In the event of an accident

- Get the child out of the water as quickly as possible.
- Call for help immediately and follow the advice given.
- Remove the wet clothes and wrap the child in warm blankets..

MEMORISE EMERGENCY SERVICE NUMBERS AND DISPLAY THEM CLOSE TO THE POOL

Fire brigade: Ambulance: Poison control centre:

(note the number of the centre closest to you)

20. GUARANTEES

20.1 Wooden components

10 year guarantee from the manufacturer against insect infestation and rotting (wood is high pressure autoclaved in accordance with the standards in effect).

This guarantee does not cover natural warping of the wood (appearance of cracks, splits that in no way impact the mechanical strength of the wood) or changes in colour attributable to weathering. Defects resulting from errors in mounting or storage are also excluded from the scope of this guarantee: deformed wall slats (exposure to sunlight, assembly deferred after opening the package), slats altered or broken due to assembly in a manner other than that set out in the installation instructions.

It should also be noted that the any cutting of wood elements, for any reason whatsoever, will cancel the guarantee against insect infestation and rotting for the altered element. Application of any treatment to the wood will also cancel the guarantee against insect infestation and rotting.

Given the constant pressure exerted by the water, the walls of the pool can bend slightly over time.

This phenomenon, due to the natural elasticity of wood, will stabilise without any intervention and will not lead to failure of the wooden slats.

This shall not be construed as a defect and will not be accepted as grounds for a guarantee claim.

20.2 Accessories

The accessoires comprising the pool are covered against manufacturing defects and assembly defects d that could impinge upon their normal use. The guarantee conditions stipulate specific periodic inspections and maintenance that must be carried out for the pool to run correctly. The successful outcome of any claim made under the aforementioned guarantee will be contingent on strict adherence to its conditions. This guarantee does not cover corrosion that may occur over time, nor does it cover damage caused by inappropriate handling during assembly or use of accessories (impacts, scratches, etc) or incidents not directly related to normal usage of the pool or its accessories. All of these guarantees apply to parts recognised as defective by our services and are limited to replacement of the implicated item(s). The costs of dismantling and reassembly are not covered.

Given the constant pressure exerted by the water, the walls may belly slightly over time. This phenomenon, due to the inherent elasticity of wood will stabilise of its own accord and will not cause the wooden slats to break. It is considered a defect, and will not be accepted as grounds for a guarantee claim.

20.3 Guarantee conditions covering components of accessories kit and optional equipment

All components of the accessories kit are covered by a 2 year guarantee.

Article	Subject and scope of the guarantee	Term of the guarantee as of the date or purchase	Conditions governing acceptance of a claim
Liner	Leaktightness of welds. The guarantee is limited to replacement or repair of the liner recognised as defective without any other damages or interest	0.50 mm liner - 2 years against leaks and stains 0.75 mm liner - 10 years against leaks -	Adherence to conditions governing fitting, use and maintenance.

CAUTION! The following problems, associated with inappropriate use or maintenance of the membrane, are not covered in the scope of the guarantee:

- Creases that appear after the liner has been fitted, these can be caused by sliding of the membrane on loose soil or an uneven surface, or physico-chemical properties of the pool water that are outside the acceptable ranges: water temperature should be less than 28°C, pH should be between 7.0 and 7.4 in pools treated with Chlorine, and between 7.4 and 8.0 in pools treated with Bromine. The concentration of the sterilising agent should be within the range recommended by the manufacturer of the water treatment products.
- If wrinkles persist as of fitting despite all installation conditions having been respected, inform the after sales service immediately.
- The appearance of yellow stains or discolouration along the water line.

These may be the result of deposition of organic compounds floating on the water surface (sun creams and oils, residue of hydrocarbon combustion or smoke from wood fires). To prevent this from happening, clean the water line regularly using products designed for this purpose (not supplied) and a non-abrasive sponge.

Very hard water can also be the cause of this type discolouration due to the build up of calcium deposits on the membrane. Hard water (TH greater than 225 ppm) should be treated with a product to eliminate calcium and suitable for use in pools (not supplied).

- Stains caused by the growth of algae and micro-organisms: the pool water should be treated regularly with an appropriate dose of algicide.
- Stains, discolouration and wrinkles caused by direct contact with oxidizing agents (thrown directly into the pool) or pockets of excessively high concentrations of oxidising agents (frequently associated with failure to run filtration during the dissolution phase of the oxidising agents).
- Stains caused by stagnation and/or decomposition of a foreign body in direct contact with the liner (dead leaves, oxidizable metallic objects, miscellaneous detritus, etc.)
- Damage caused by direct contact with incompatible materials such as bitumen, tar, oils, polystyrene panels, polyurethane. Never apply adhesive tape or glue to the membrane.
- Tears that occur while fitting the liner caused by shifting the liner without releasing it from the liner locking track first.

CAUTION ! The following problems, associated with inappropriate use of the filtration components, are not covered under the terms of this guarantee :

Article	Subject and scope of the guarantee	Term of the guarantee as of the date of purchase	Conditions governing acceptance of a claim
Pool fittings	Leaktightness and durability of the pool fittings	10 years	
Filter + connection components	Leaktightness of the filter tank Leaktightness of the pre-assembled connection elements (rigid descending pipes)	5 years on the filter tank	The hydraulic installation, and notably the pump, should generate an operating pressure less than 1.2 bar. Regular back washes to clean the filter to avoid clogging of the filter medium.

- Leaks caused by running the filter at an operating pressure greater than 1.2 bar (use of a pump that is too powerful, clogged filter medium, etc.), or installing the filter above the water level without a vent and check valve. (see the installation instructions)
- “stress-cracking” of ABS parts (valve, nuts) caused by surface reactants found in some types of grease: grease should not be used on these types of components.
- The continuous expulsion of sand if sand with a grain size of less than 0.6 mm is used (the sand supplied has the correct grain size)..

Article	Subject and scope of the guarantee	Term of the guarantee as of the date or purchase	Conditions governing acceptance of a claim
Pump	Motor operation Operation and leaktightness of the hydraulic components.	2 years	See below + regular cleaning

CAUTION! The following problems, associated with inappropriate use of the pump, are not covered under the terms of this guarantee:

- Running the pump “dry” (absence of water, clogging of the pre-filter)
- Running the pump without the pre-filter.

PROCOPI BWT group
 Les Landes d’Apigné
 35653 LE RHEU cedex
 FRANCE

21. EXPLODED VIEW - OCTO WOODEN STRUCTURE

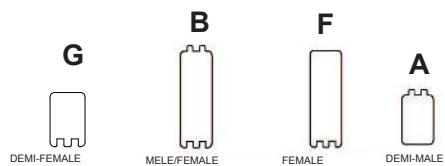
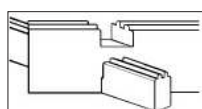
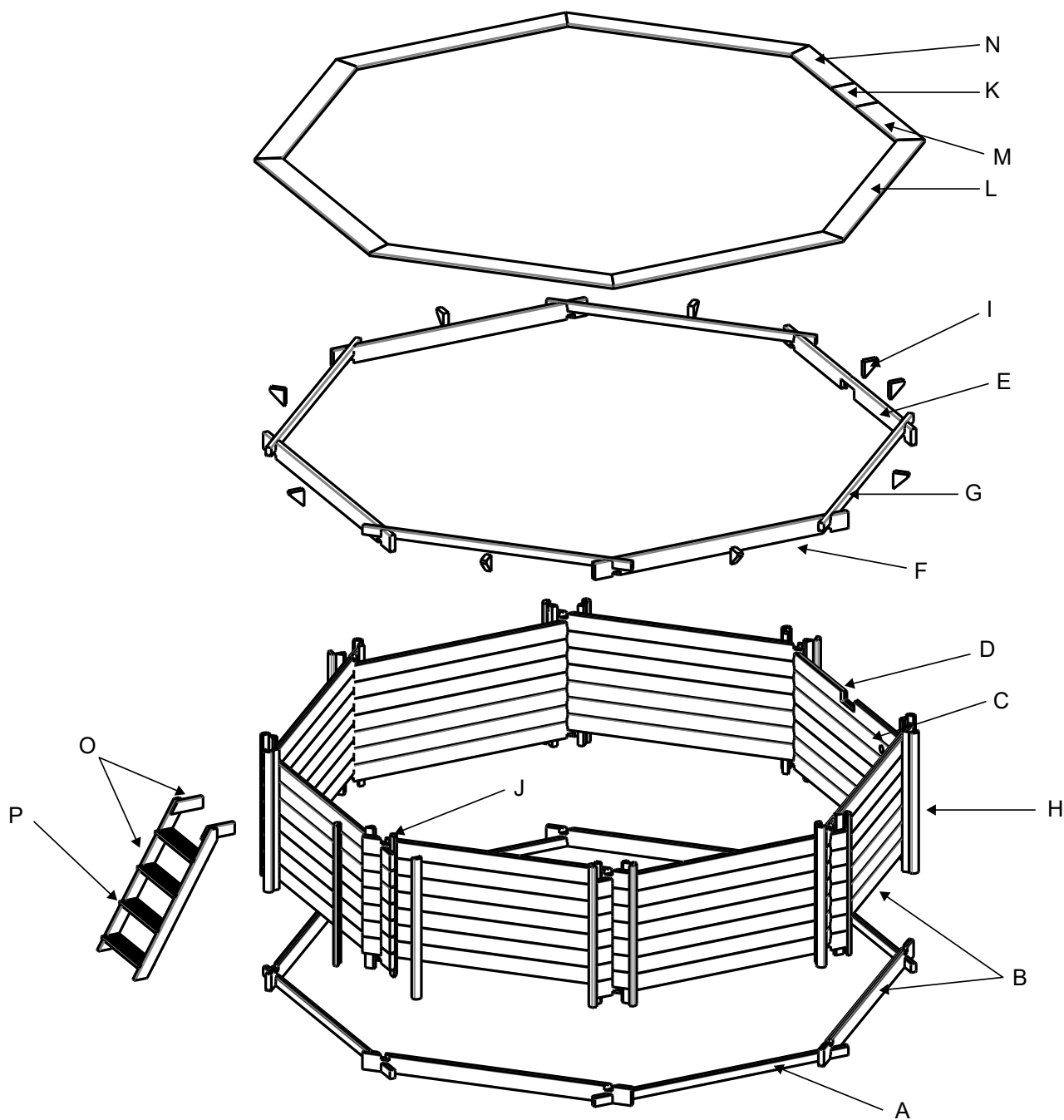

22. EXPLODED VIEW - OCTO + WOODEN STRUCTURE

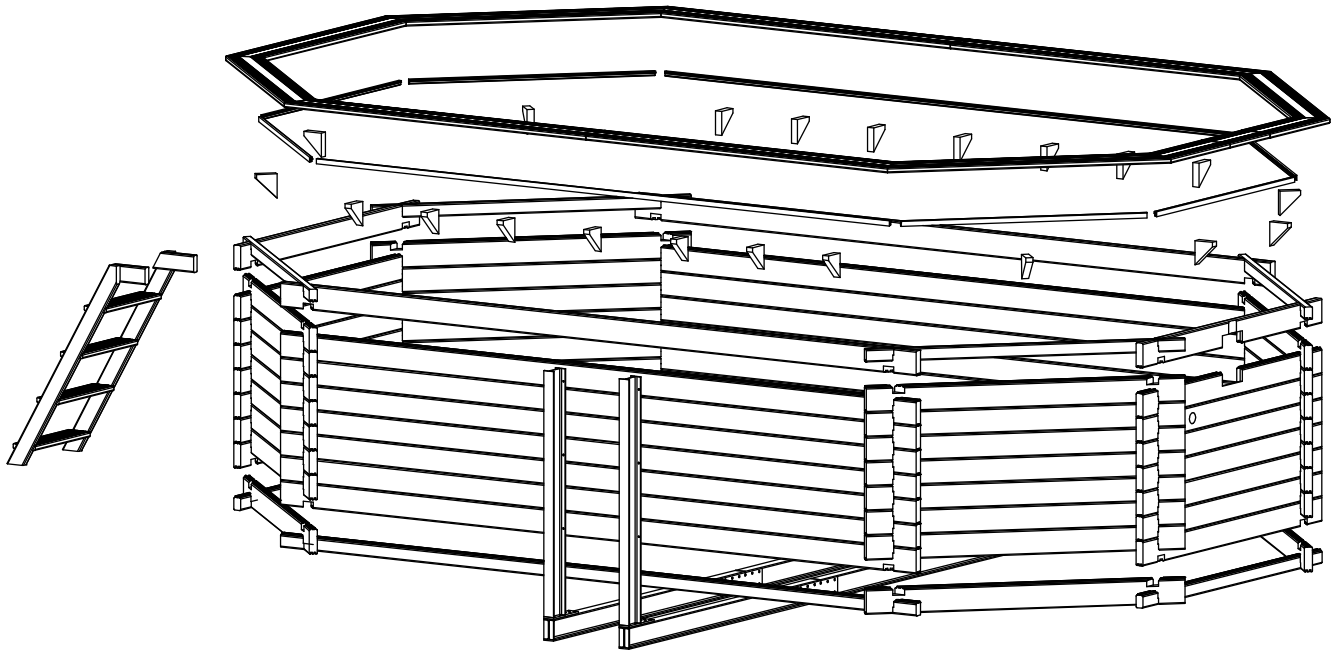



ATTESTATION DE CERTIFICATION

CERTIFICATE OF

CHAINE DE CONTRÔLE PEFC CHAIN OF CUSTODY PEFC CERTIFICATION

Société / Company : PROCOPI
35137 PLEUMELEUC
N° Chaîne de contrôle : FCBA/12-01382
Chain of Custody N°

Produits Products Categories	Domaine d'application Scope	Méthode utilisée Method	Origine des matières premières Raw materials origin
09010 - Constructions et leurs éléments Buildings and their parts	Fabricant d'aménagements extérieur en bois Wooden outdoor accommodations manufacturing	Transfert en pourcentage moyen Average percentage method	Certifiée Certified

La chaîne de contrôle de l'entreprise ci-dessus désignée est en conformité avec les exigences PEFC* en vigueur.

The chain of custody of the company appointed above is in compliance with the requirements PEFC in force.

Ce certificat est délivré selon le règlement de gestion de chaîne de contrôle PEFC de FCBA en vigueur.

This certificate is delivered according to the FCBA requirements for the PEFC chain of custody

* standards PEFC/FR ST 2002 : 2013 et PEFC/FR ST 2001 :2008 du schéma français de certification forestière 2017-2022, traduction des standards PEFC ST 2002 : 2013 et PEFC ST 2001 :2008 du document technique de PEFC C

Ce certificat atteste la vérification de la chaîne de contrôle PEFC, fondée sur un contrôle permanent. Il ne peut préjuger d'évolutions ou de décisions qui seraient prises en cours d'année. La liste des entreprises sous certification est disponible sur les sites Internet : www.fcba.fr et www.pefc.org.

This document testifies the certification of PEFC chain of custody, based on a permanent assessment. There can not be any evolution or decision which would be taken in the course of the year after examination of the results of the audits of follow-up. This document is the property of FCBA. In case of the mark's withdrawal, the original and all the copies must have returned to FCBA.



Siège Social
10, rue Galilée
CS 81050 Champs sur Mame
77447 Mame la Vallée Cedex 2
www.fcba.fr

Numéro de Certificat : 00010258

Certificate Nr :

Annule et remplace N°

Cancel and replace :

Date d'émission : 02/02/2022

Issued :

Valable jusqu'au : 01/02/2027

Valid until :

Nombre de pages / 1

Pages :

LE DÉCIDEUR
TECHNIQUE

Jérôme MONTEFERRARIO

LE DIRECTEUR
CERTIFICATION

Alain HOCQUET

Serial number



HOTLINE 0 892 686 970

Service 0,60 € / min
* prix appel